



## **InGranite Recon Ltd.**

Cast Stone | Modern Material | Classic Style

# Wall & Pier Coping

### Contact

Phone:

Email:

Web:

### UK

0808 2349 118

[info@ingranite.co.uk](mailto:info@ingranite.co.uk)

[www.ingranite.co.uk](http://www.ingranite.co.uk)

### Rep. Irl.

057 9331 462

[info@ingranite.ie](mailto:info@ingranite.ie)

[www.ingranite.ie](http://www.ingranite.ie)







## **InGranite Recon Ltd.**

Cast Stone | Modern Material | Classic Style

# Wall & Pier Coping

InGranite Recon manufactures a wide range of cast stone wall and pier coping styles in beautiful and durable reconstituted granite. With plenty of profile designs and widths to choose from, you are sure to find just the right one for your build project.

### **A Word on Terminology**

Our standard, ex-stock wall caps are available in Saddle-Back (Twice-Weathered), Feather-Edged (Once-Weathered), Flat (Tabled), and Flat-topped (Chamfered). Feel free to use the names that you are used to when contacting us. We have been manufacturing wall coping for many years, so we'll know what you mean.

#### **Contact**

Phone:  
Email:  
Web:

#### **UK**

0808 2349 118  
info@ingranite.co.uk  
www.ingranite.co.uk

#### **Contact**

057 9331 462  
info@ingranite.ie  
www.ingranite.ie



# InGranite Recon Ltd.

Reconstituted Stone | Modern Material | Classic Style

UK info@ingranite.co.uk

www.ingranite.co.uk

0808 2349118

RoI info@ingranite.ie

www.ingranite.ie

057 9331462

## Technical specification sheet

Title: Feather edge wall caps A

Date: 27/02/2017

Ref: FE .....

Scale: 1:10

Drawn by: InGranite

Approximate weight: 68kgs/136.5kgs

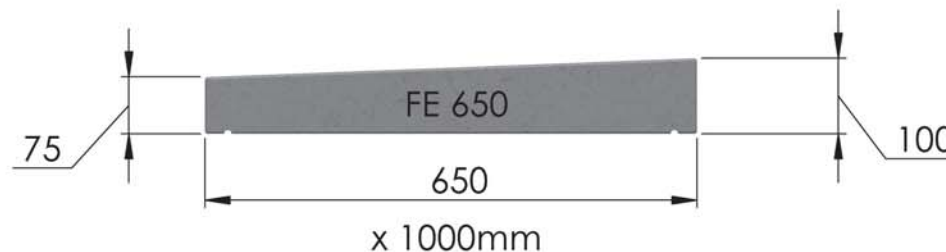
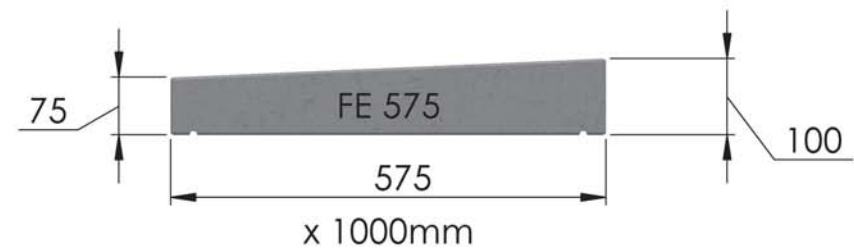
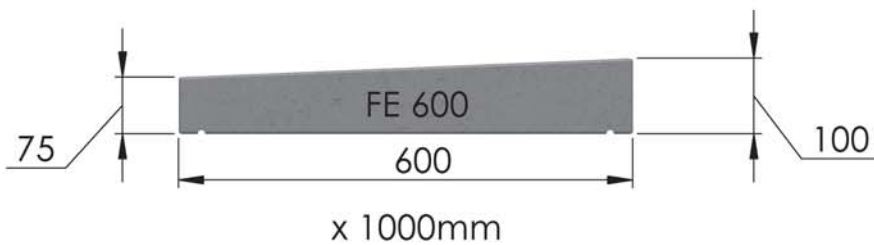
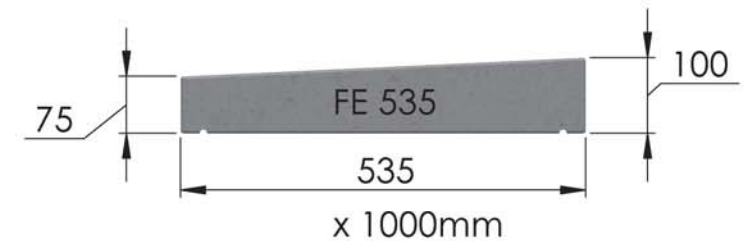
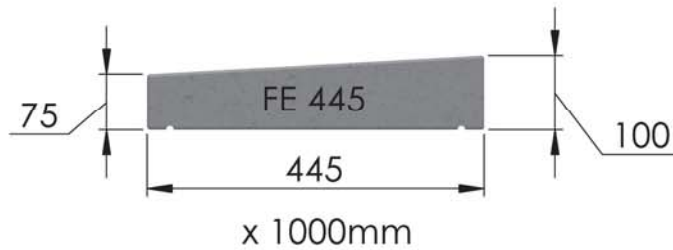
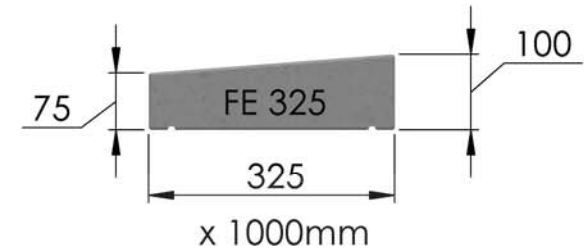
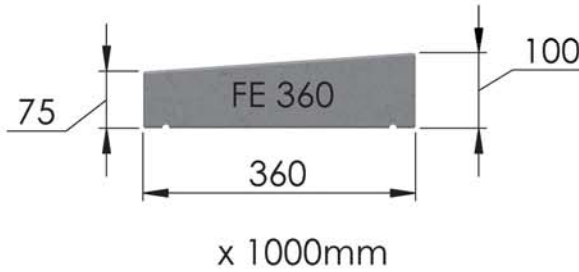

All dimensions are in millimetres. For non listed sizes please contact InGranite Recon LTD.

All vertical faces typically have a 4mm taper per 100mm of height.

The information contained in this drawing was correct at the time of going to print. Profiles, sizes and weights are given as indication only.



# InGranite Recon Ltd.

Reconstituted Stone | Modern Material | Classic Style

UK info@ingranite.co.uk

www.ingranite.co.uk

0808 2349118

RoI info@ingranite.ie

www.ingranite.ie

057 9331462

## Technical specification sheet

Title: Feather edge wall caps B

Date: 27/02/2017

Ref: FE.....

Scale: 1:10

Drawn by: InGranite

Approximate weight:

86kgs/180kgs

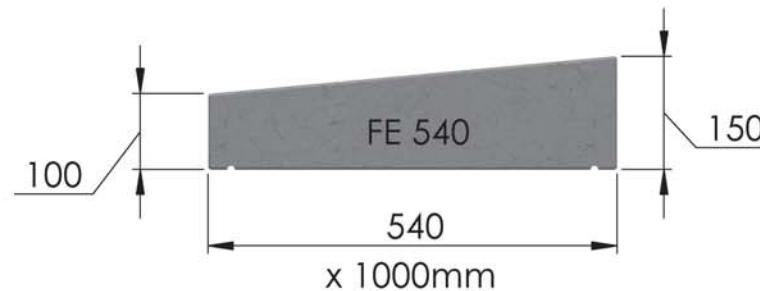
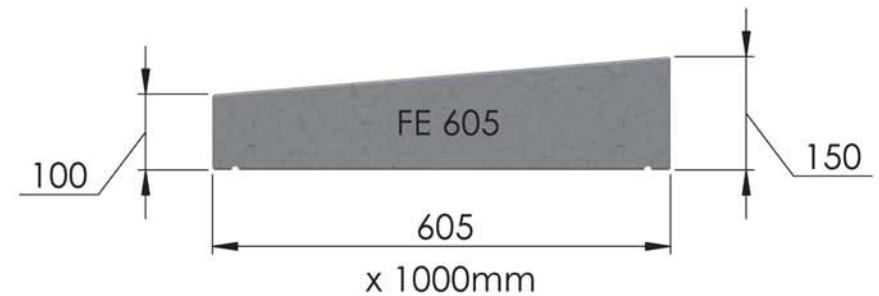
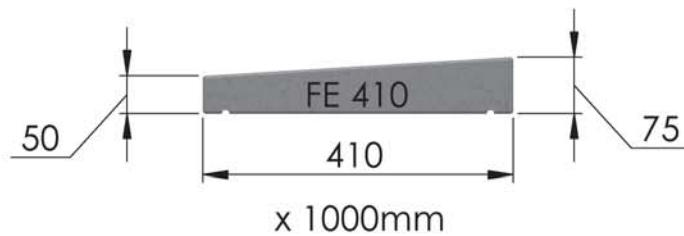
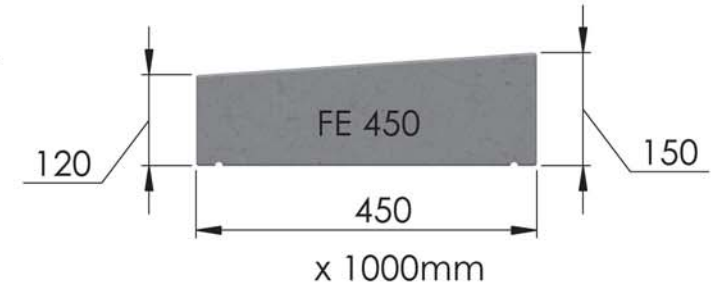
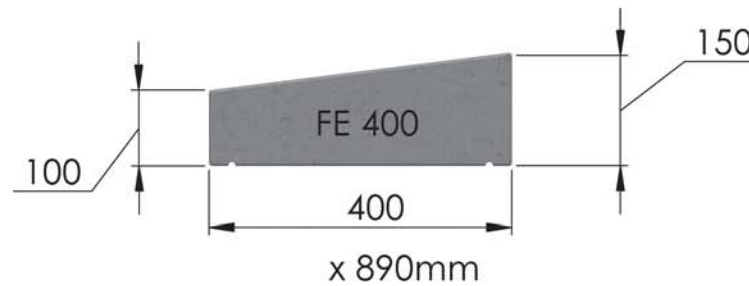

All dimensions are in millimetres. For non listed sizes please contact InGranite Recon LTD.

All vertical faces typically have a 4mm taper per 100mm of height.

The information contained in this drawing was correct at the time of going to print. Profiles, sizes and weights are given as indication only.



# InGranite Recon Ltd.

Reconstituted Stone | Modern Material | Classic Style

UK info@ingranite.co.uk

www.ingranite.co.uk

0808 2349118

RoI info@ingranite.ie

www.ingranite.ie

057 9331462

## Technical specification sheet

Title: 325 Feather edge wall cap

Date: 27/02/2017

Ref: FE 325

Scale: 1:10

Drawn by: InGranite

Approximate weight: 68kgs

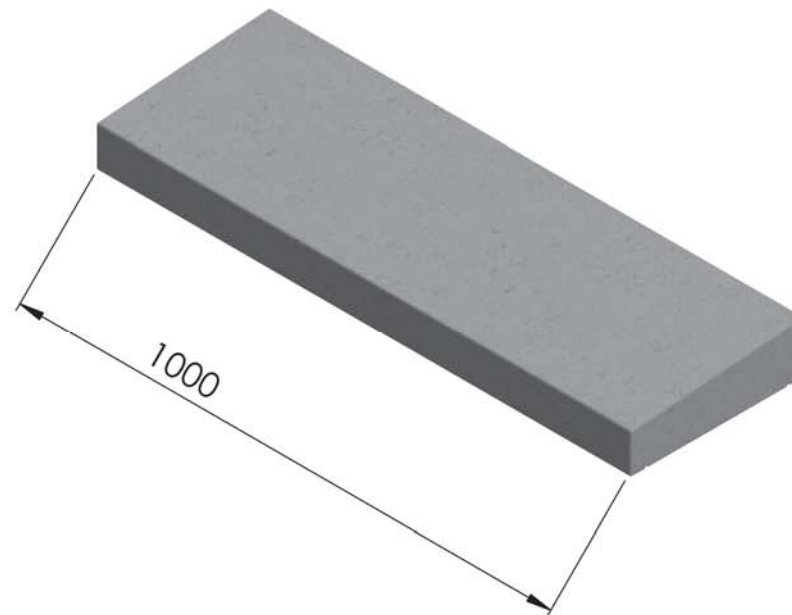
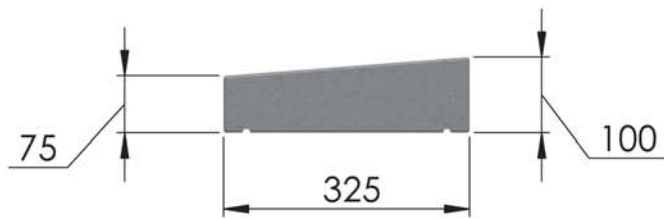
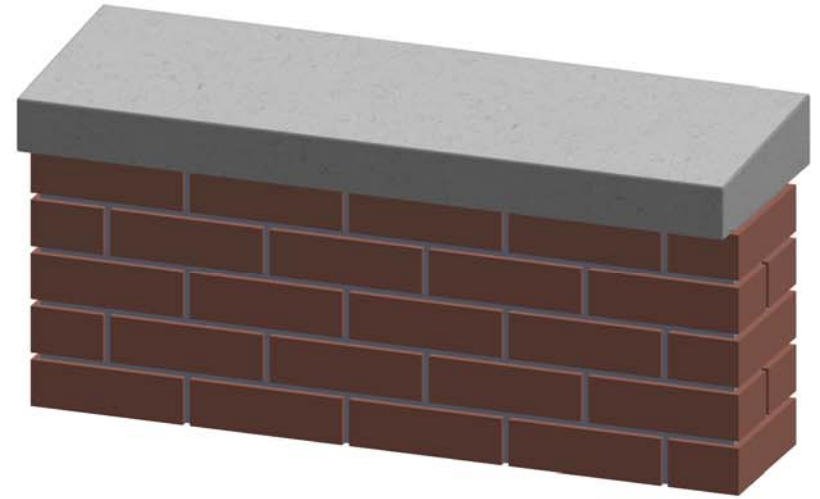

All dimensions are in millimetres. For non listed sizes please contact InGranite Recon LTD.

All vertical faces typically have a 4mm taper per 100mm of height.

The information contained in this drawing was correct at the time of going to print. Profiles, sizes and weights are given as indication only.



# InGranite Recon Ltd.

Reconstituted Stone | Modern Material | Classic Style

UK info@ingranite.co.uk

www.ingranite.co.uk

0808 2349118

RoI info@ingranite.ie

www.ingranite.ie

057 9331462

## Technical specification sheet

Title: 360 Feather edge wall cap

Date: 27/02/2017

Ref: FE 360

Scale: 1:10

Drawn by: InGranite

Approximate weight: 75.5kgs

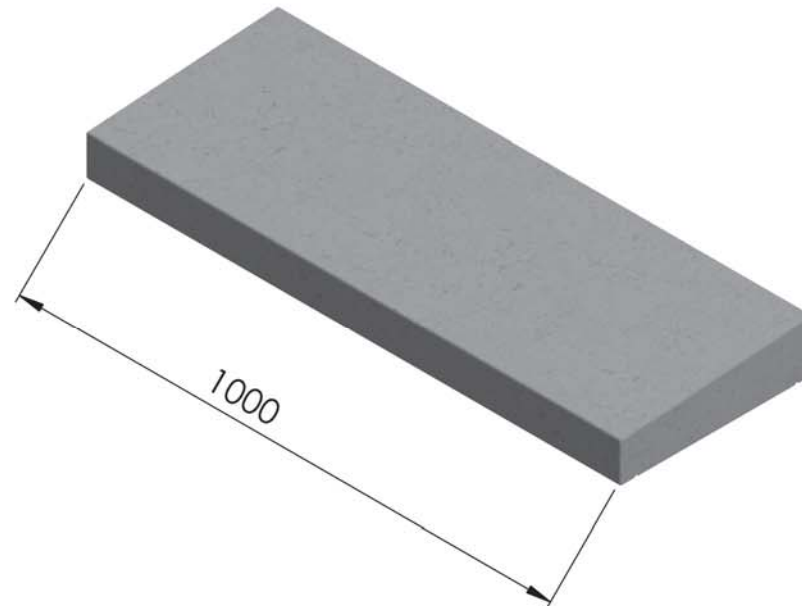
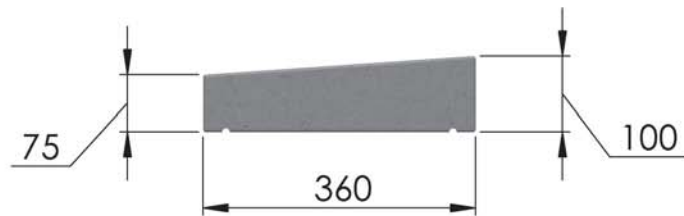
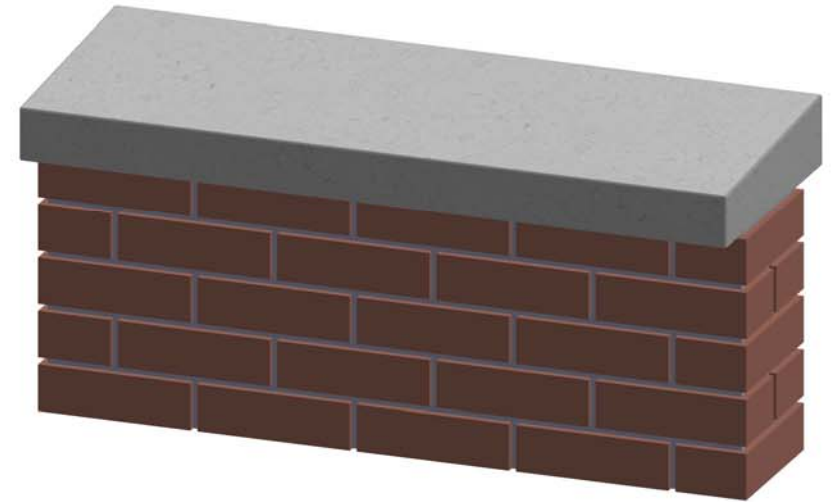

All dimensions are in millimetres. For non listed sizes please contact InGranite Recon LTD.

All vertical faces typically have a 4mm taper per 100mm of height.

The information contained in this drawing was correct at the time of going to print. Profiles, sizes and weights are given as indication only.



# InGranite Recon Ltd.

Reconstituted Stone | Modern Material | Classic Style

UK info@ingranite.co.uk

www.ingranite.co.uk

0808 2349118

RoI info@ingranite.ie

www.ingranite.ie

057 9331462

## Technical specification sheet

Title: 400 Feather edge wall cap

Date: 27/02/2017

Ref: FE 400

Scale: 1:10

Drawn by: InGranite

Approximate weight: 107kgs

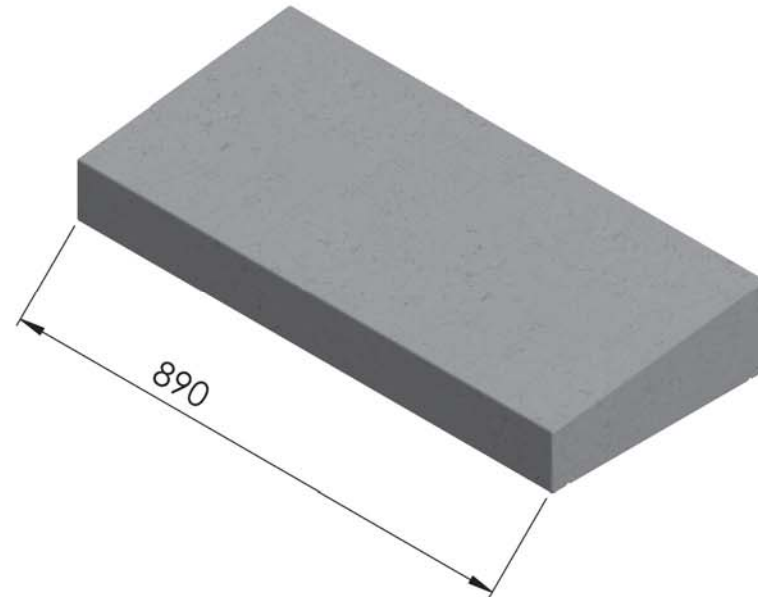
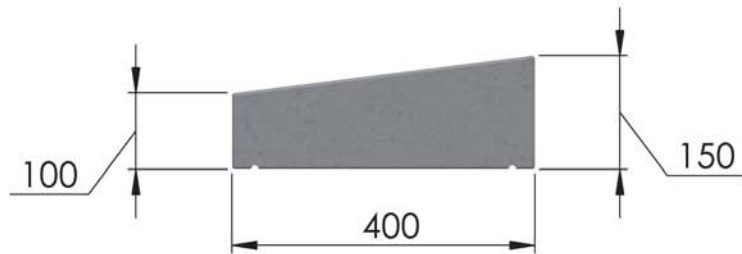
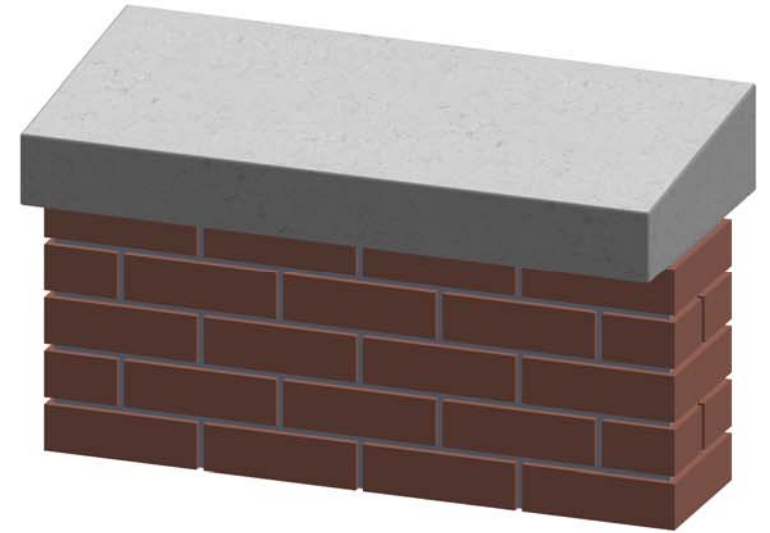

All dimensions are in millimetres. For non listed sizes please contact InGranite Recon LTD.

All vertical faces typically have a 4mm taper per 100mm of height.

The information contained in this drawing was correct at the time of going to print. Profiles, sizes and weights are given as indication only.





# InGranite Recon Ltd.

Reconstituted Stone | Modern Material | Classic Style

UK info@ingranite.co.uk

www.ingranite.co.uk

0808 2349118

RoI info@ingranite.ie

www.ingranite.ie

057 9331462

## Technical specification sheet

Title: 410 Feather edge wall cap

Date: 27/02/2017

Ref: FE 410

Scale: 1:10

Drawn by: InGranite

Approximate weight:

61.5kgs

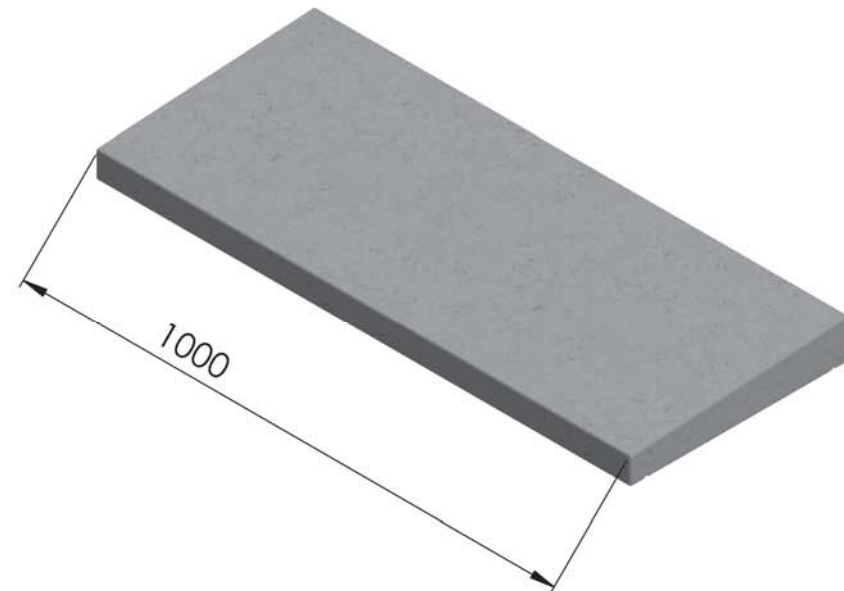
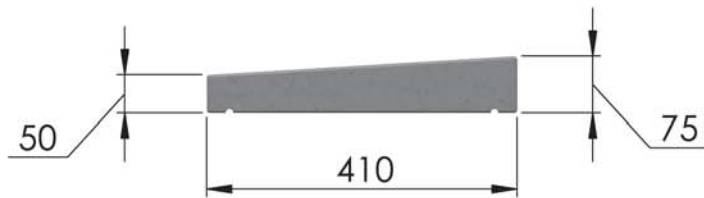
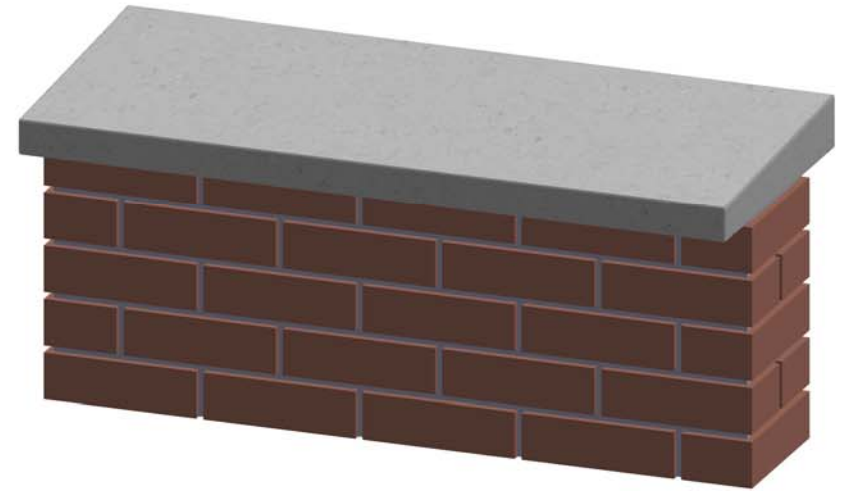

All dimensions are in millimetres. For non listed sizes please contact InGranite Recon LTD.

All vertical faces typically have a 4mm taper per 100mm of height.

The information contained in this drawing was correct at the time of going to print. Profiles, sizes and weights are given as indication only.



# InGranite Recon Ltd.

Reconstituted Stone | Modern Material | Classic Style

UK info@ingranite.co.uk

www.ingranite.co.uk

0808 2349118

RoI info@ingranite.ie

www.ingranite.ie

057 9331462

## Technical specification sheet

Title: 445 Feather edge wall cap

Date: 27/02/2017

Ref: FE 445

Scale: 1:10

Drawn by: InGranite

Approximate weight:

93.5kgs

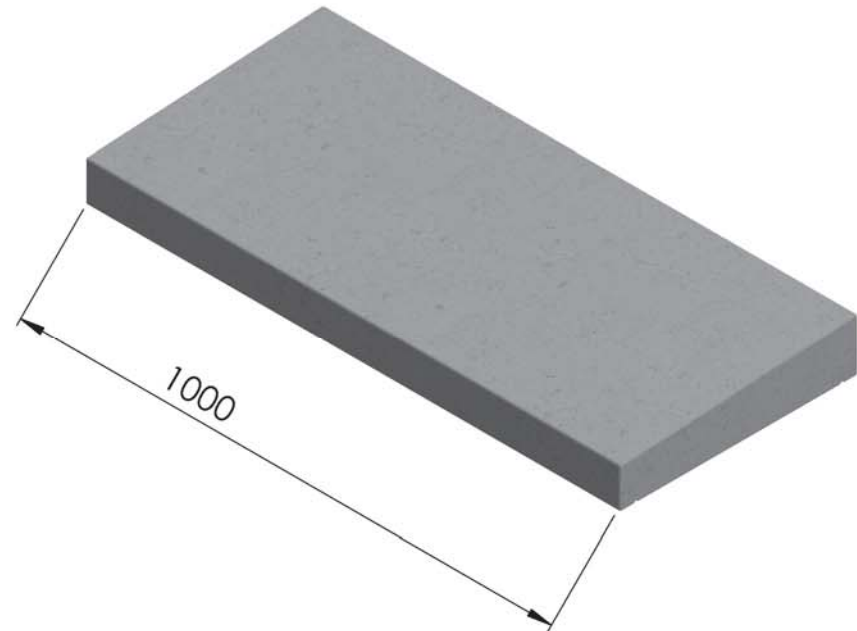
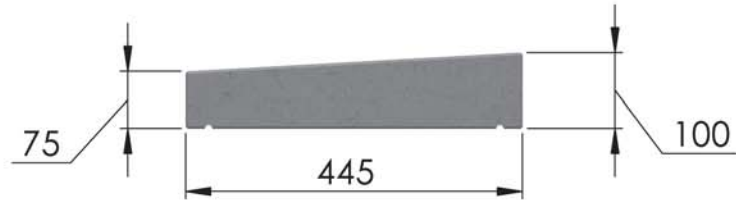
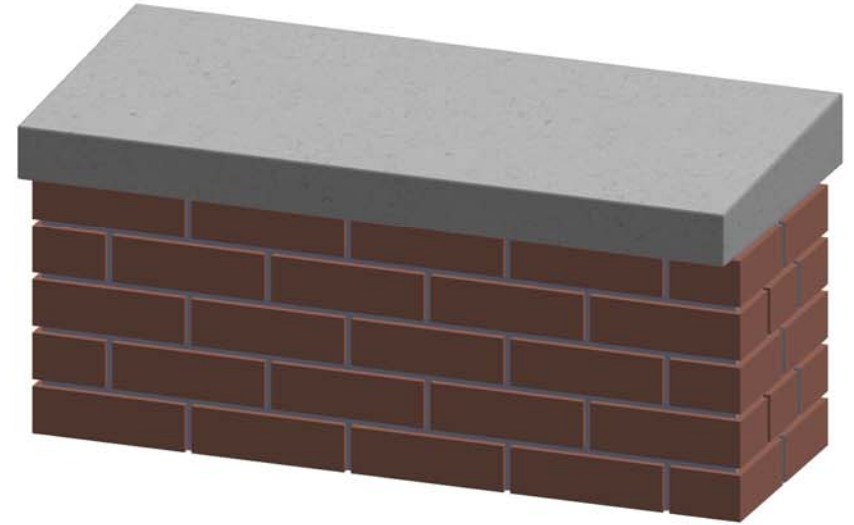

All dimensions are in millimetres. For non listed sizes please contact InGranite Recon LTD.

All vertical faces typically have a 4mm taper per 100mm of height.

The information contained in this drawing was correct at the time of going to print. Profiles, sizes and weights are given as indication only.



# InGranite Recon Ltd.

Reconstituted Stone | Modern Material | Classic Style

UK info@ingranite.co.uk

www.ingranite.co.uk

0808 2349118

RoI info@ingranite.ie

www.ingranite.ie

057 9331462

## Technical specification sheet

Title: 450 Feather edge wall cap

Date: 27/02/2017

Ref: FE 450

Scale: 1:10

Drawn by: InGranite

Approximate weight:

146kgs

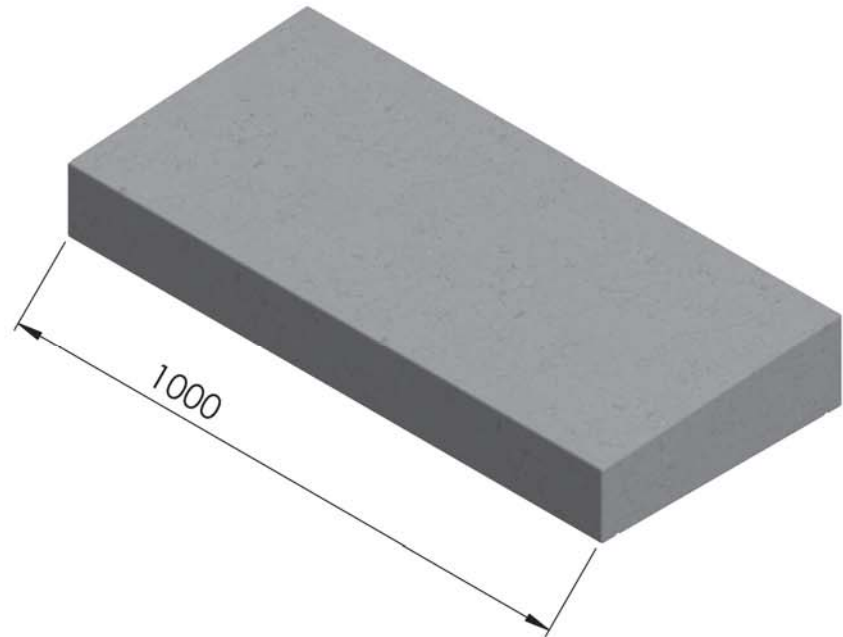
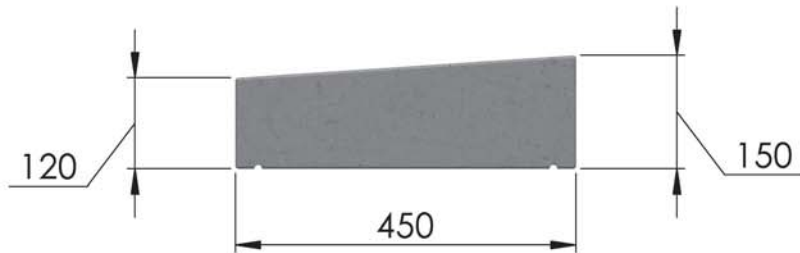
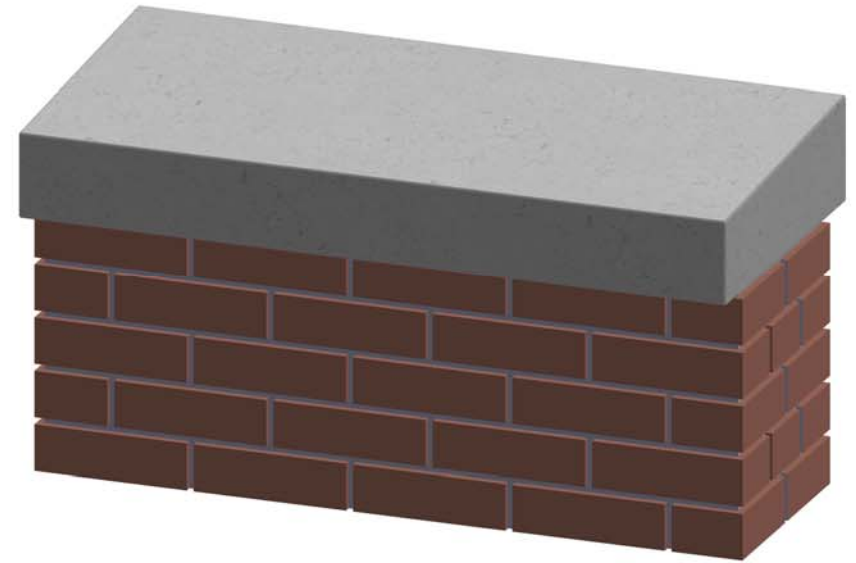

All dimensions are in millimetres. For non listed sizes please contact InGranite Recon LTD.

All vertical faces typically have a 4mm taper per 100mm of height.

The information contained in this drawing was correct at the time of going to print. Profiles, sizes and weights are given as indication only.



# InGranite Recon Ltd.

Reconstituted Stone | Modern Material | Classic Style

UK info@ingranite.co.uk

www.ingranite.co.uk

0808 2349118

RoI info@ingranite.ie

www.ingranite.ie

057 9331462

## Technical specification sheet

Title: 535 Feather edge wall cap

Date: 27/02/2017

Ref: FE 535

Scale: 1:10

Drawn by: InGranite

Approximate weight:

112.5kgs

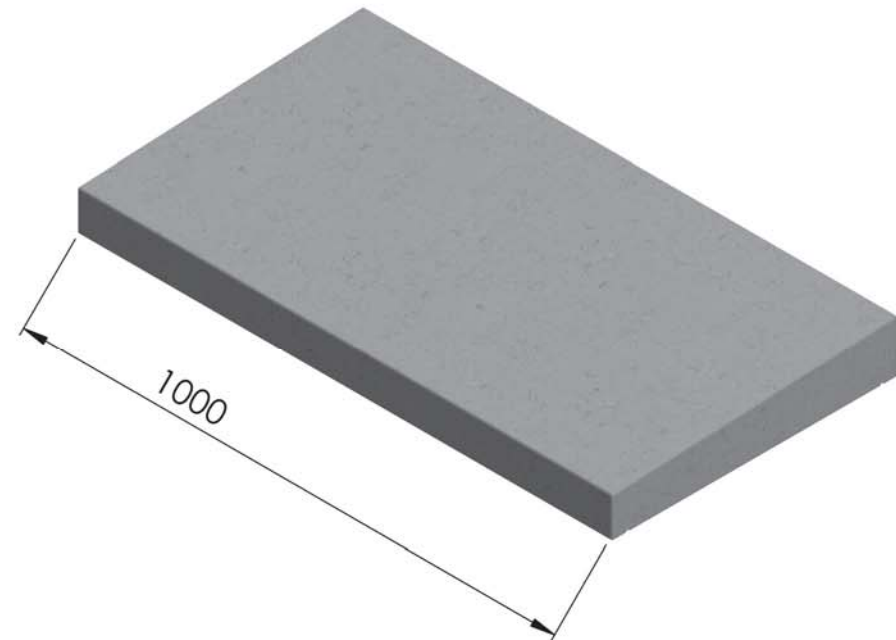
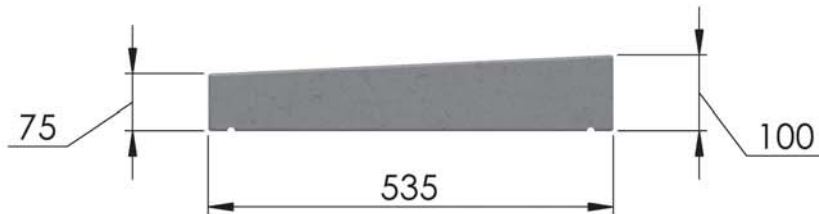
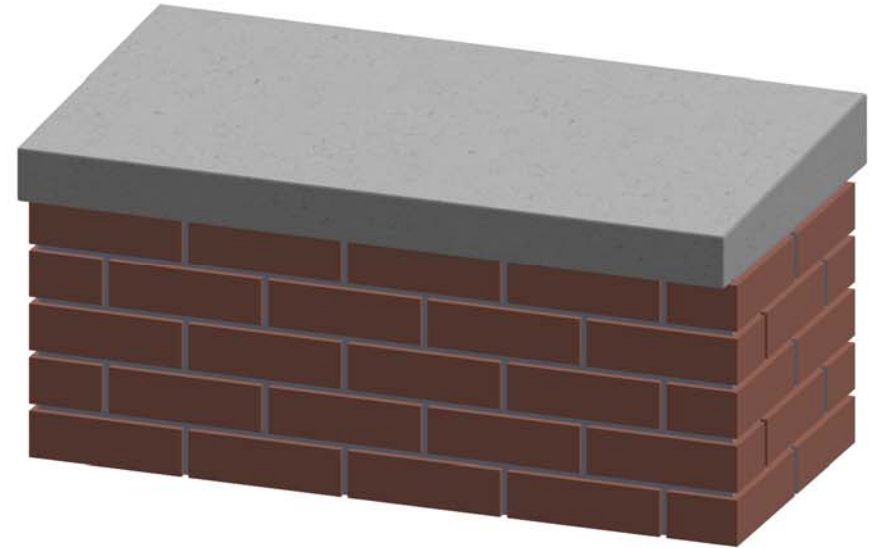

All dimensions are in millimetres. For non listed sizes please contact InGranite Recon LTD.

All vertical faces typically have a 4mm taper per 100mm of height.

The information contained in this drawing was correct at the time of going to print. Profiles, sizes and weights are given as indication only.



# InGranite Recon Ltd.

Reconstituted Stone | Modern Material | Classic Style

UK info@ingranite.co.uk

www.ingranite.co.uk

0808 2349118

RoI info@ingranite.ie

www.ingranite.ie

057 9331462

## Technical specification sheet

Title: 540 Feather edge wall cap

Date: 27/02/2017

Ref: FE 540

Scale: 1:10

Drawn by: InGranite

Approximate weight: 160.5kgs

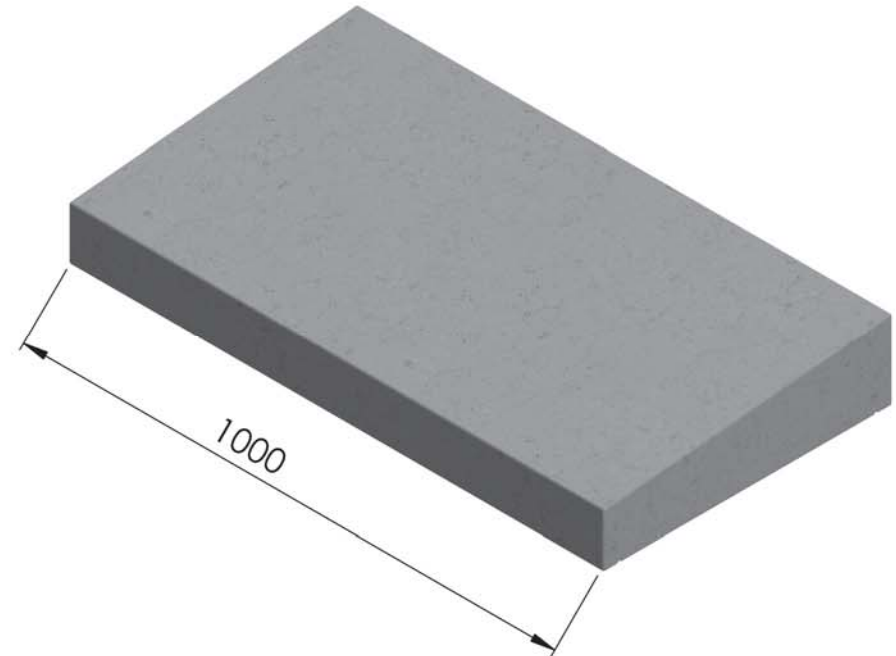
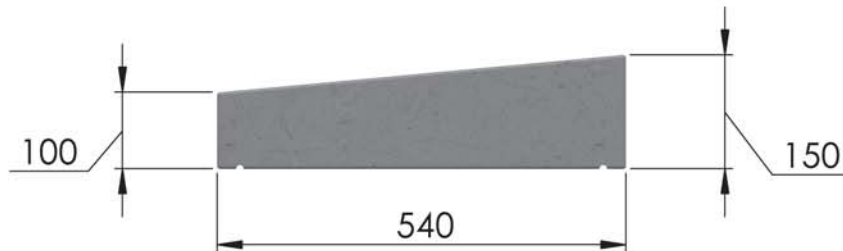
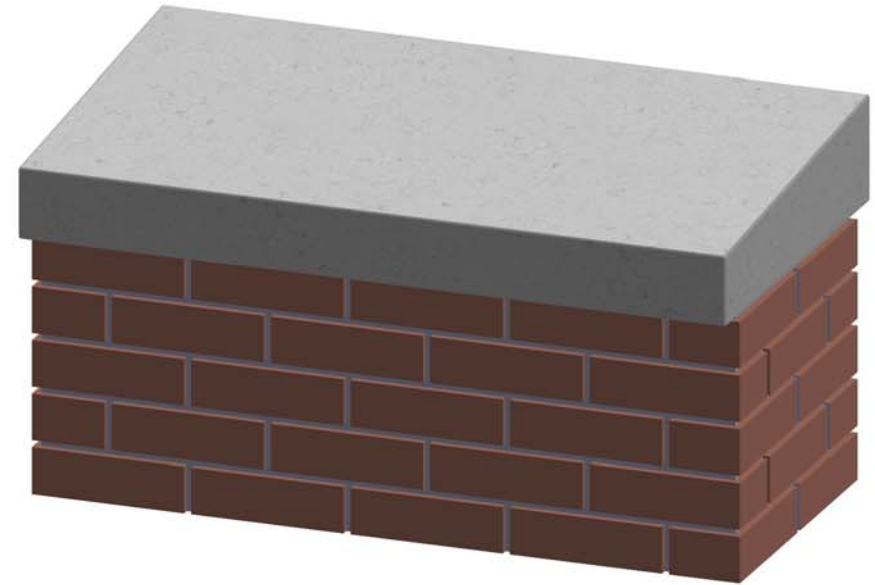

All dimensions are in millimetres. For non listed sizes please contact InGranite Recon LTD.

All vertical faces typically have a 4mm taper per 100mm of height.

The information contained in this drawing was correct at the time of going to print. Profiles, sizes and weights are given as indication only.



# InGranite Recon Ltd.

Reconstituted Stone | Modern Material | Classic Style

UK info@ingranite.co.uk

www.ingranite.co.uk

0808 2349118

RoI info@ingranite.ie

www.ingranite.ie

057 9331462

## Technical specification sheet

Title: 575 Feather edge wall cap

Date: 27/02/2017

Ref: FE 575

Scale: 1:10

Drawn by: InGranite

Approximate weight:

121kgs

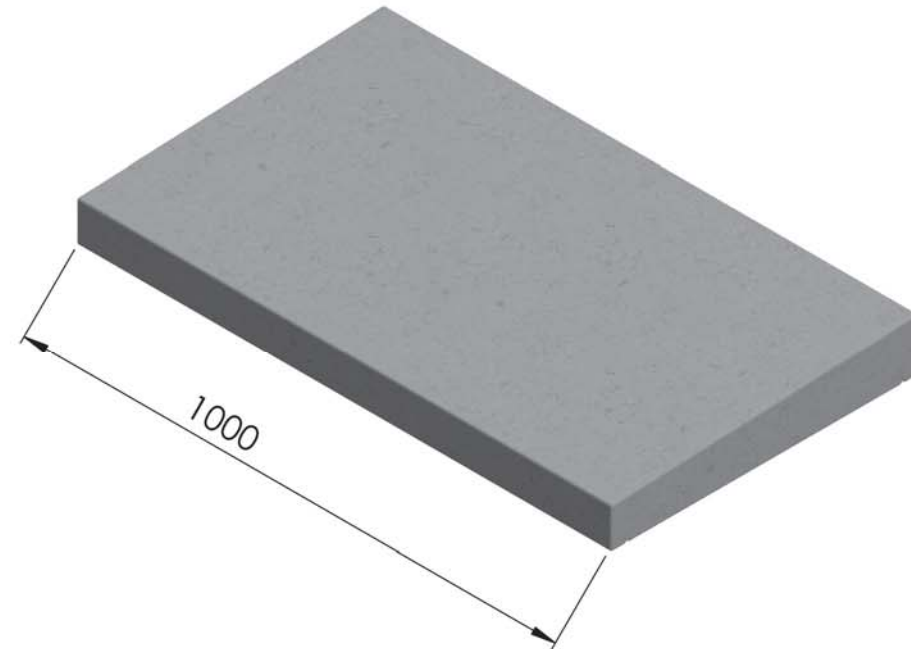
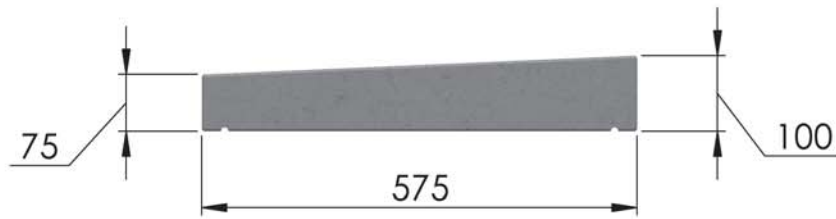
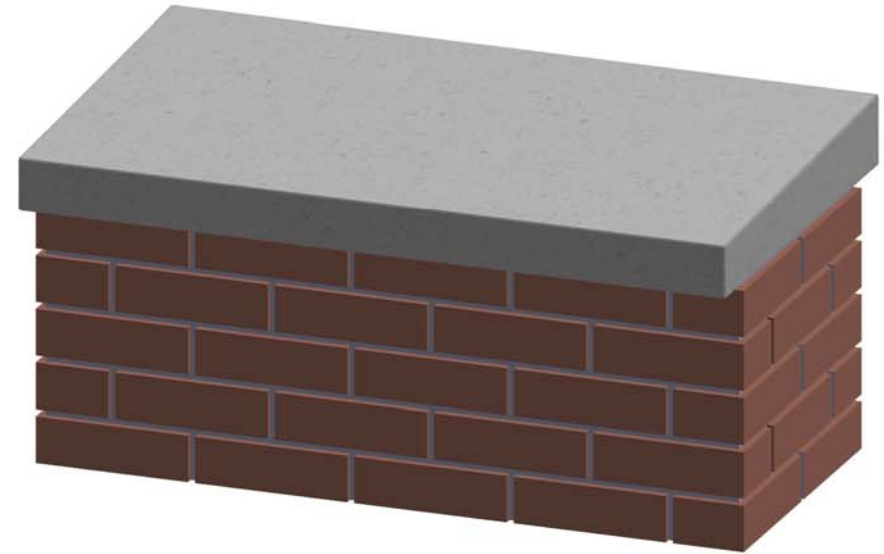

All dimensions are in millimetres. For non listed sizes please contact InGranite Recon LTD.

All vertical faces typically have a 4mm taper per 100mm of height.

The information contained in this drawing was correct at the time of going to print. Profiles, sizes and weights are given as indication only.



# InGranite Recon Ltd.

Reconstituted Stone | Modern Material | Classic Style

UK info@ingranite.co.uk

www.ingranite.co.uk

0808 2349118

RoI info@ingranite.ie

www.ingranite.ie

057 9331462

## Technical specification sheet

Title: 600 Feather edge Wall cap

Date: 27/02/2017

Ref: FE 600

Scale: 1:10

Drawn by: InGranite

Approximate weight:

127kgs

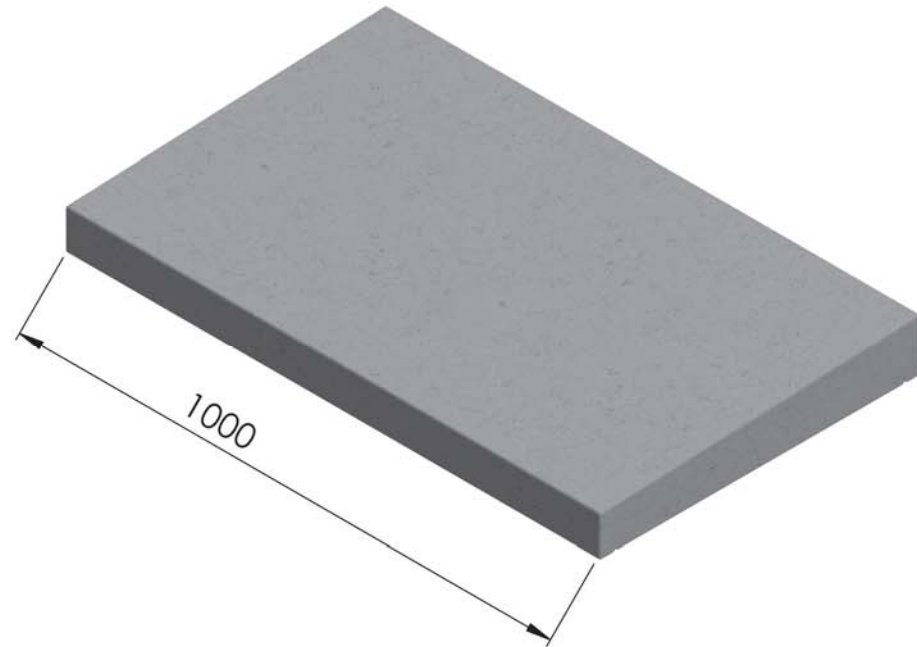
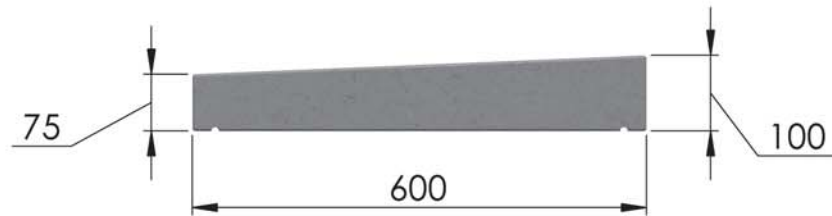
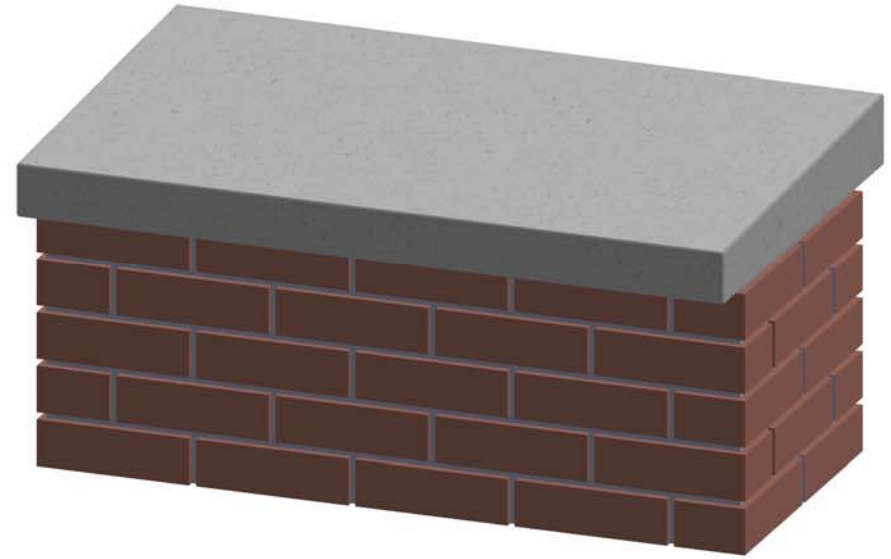

All dimensions are in millimetres. For non listed sizes please contact InGranite Recon LTD.

All vertical faces typically have a 4mm taper per 100mm of height.

The information contained in this drawing was correct at the time of going to print. Profiles, sizes and weights are given as indication only.



# InGranite Recon Ltd.

Reconstituted Stone | Modern Material | Classic Style

UK info@ingranite.co.uk

www.ingranite.co.uk

0808 2349118

RoI info@ingranite.ie

www.ingranite.ie

057 9331462

## Technical specification sheet

Title: 605 Feather edge wall cap

Date: 27/02/2017

Ref: FE 605

Scale: 1:10

Drawn by: InGranite

Approximate weight: 180kgs

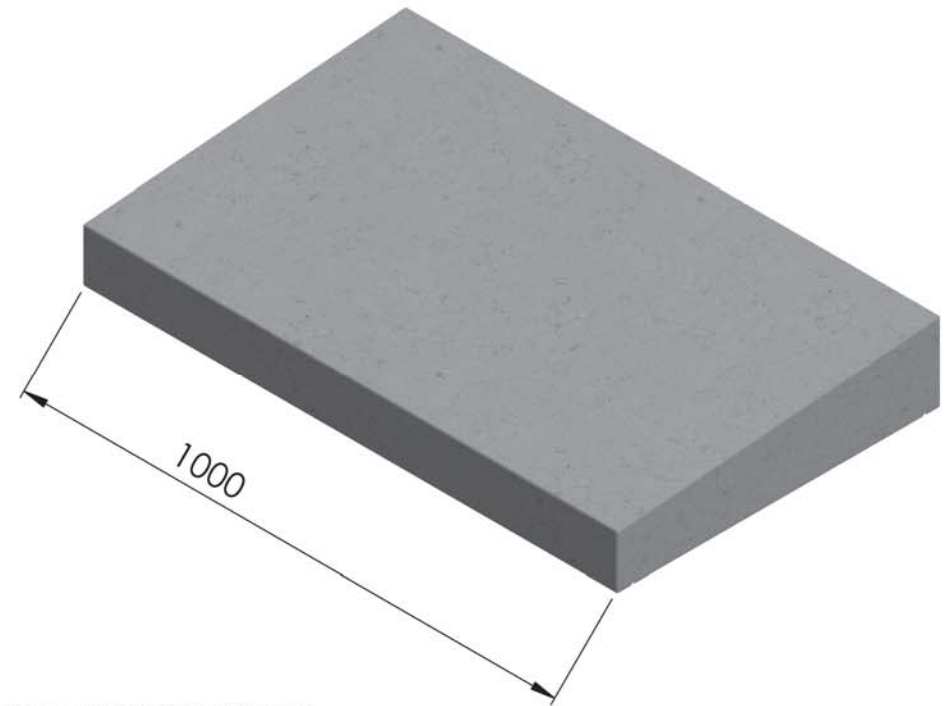
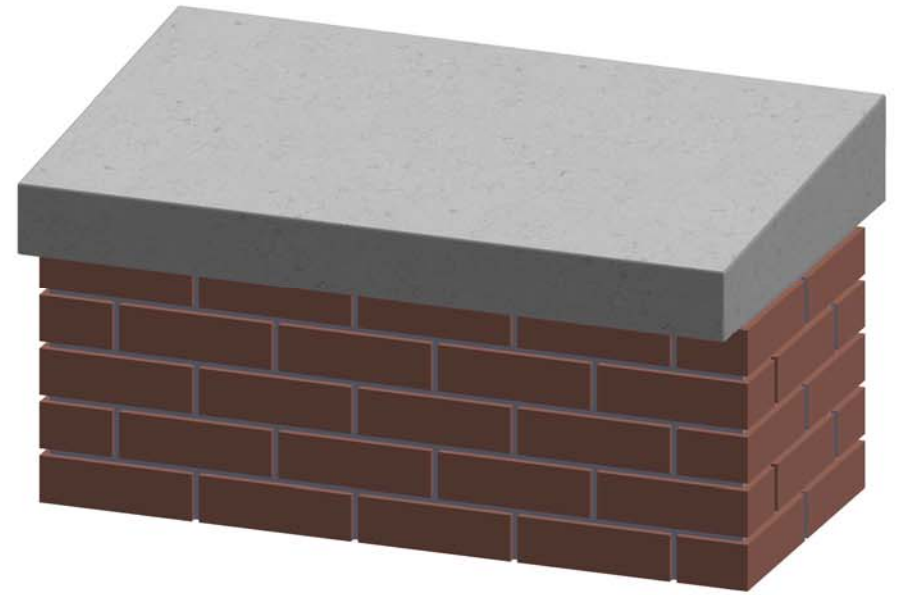
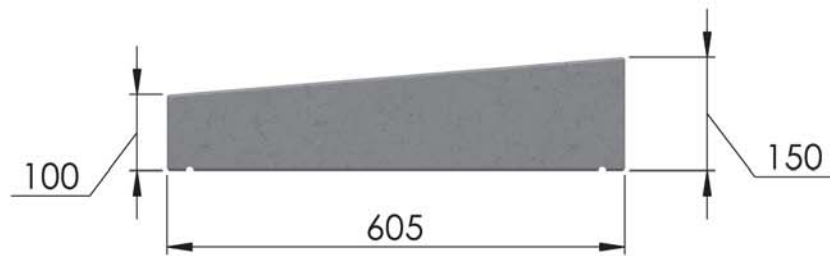

All dimensions are in millimetres. For non listed sizes please contact InGranite Recon LTD.

All vertical faces typically have a 4mm taper per 100mm of height.

The information contained in this drawing was correct at the time of going to print. Profiles, sizes and weights are given as indication only.





# InGranite Recon Ltd.

Reconstituted Stone | Modern Material | Classic Style

UK info@ingranite.co.uk

www.ingranite.co.uk

0808 2349118

RoI info@ingranite.ie

www.ingranite.ie

057 9331462

## Technical specification sheet

Title: 650 Feather edge wall cap

Date: 27/02/2017

Ref: FE 650

Scale: 1:10

Drawn by: InGranite

Approximate weight: 136.5kgs

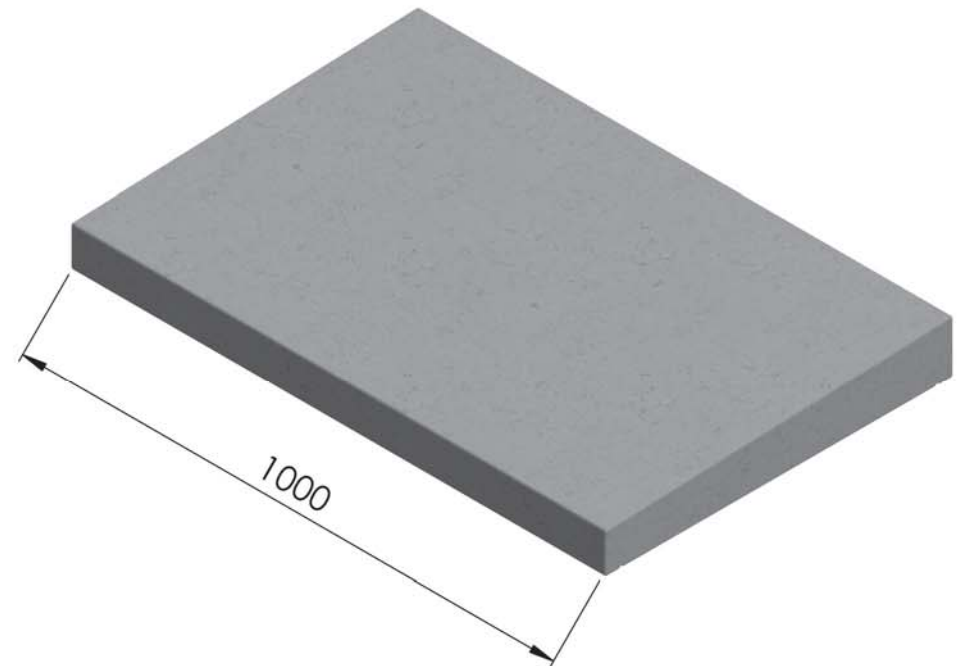
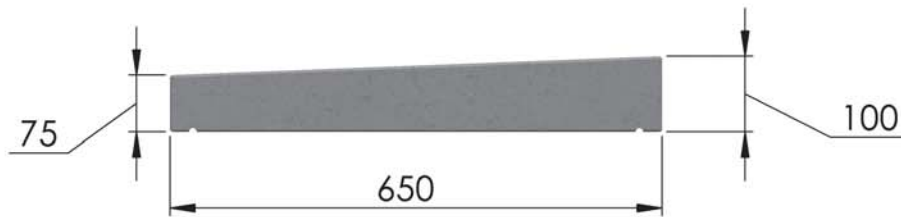
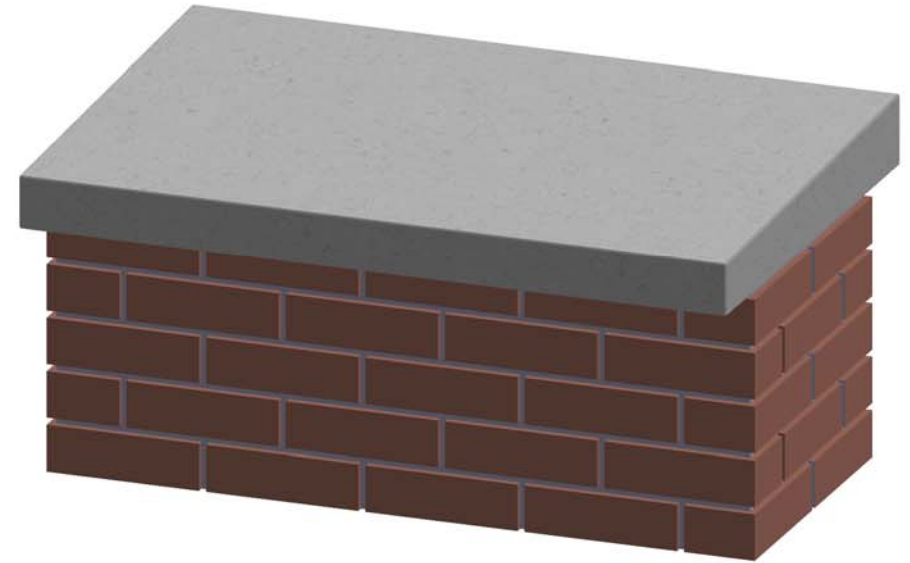

All dimensions are in millimetres. For non listed sizes please contact InGranite Recon LTD.

All vertical faces typically have a 4mm taper per 100mm of height.

The information contained in this drawing was correct at the time of going to print. Profiles, sizes and weights are given as indication only.



# InGranite Recon Ltd.

Reconstituted Stone | Modern Material | Classic Style

UK info@ingranite.co.uk

www.ingranite.co.uk

0808 2349118

RoI info@ingranite.ie

www.ingranite.ie

057 9331462

## Technical specification sheet

Title: Saddle back wall caps

Date: 27/02/2017

Ref: SB....

Scale: 1:6

Drawn by: InGranite

Approximate weight:

24kgs - 132 kgs

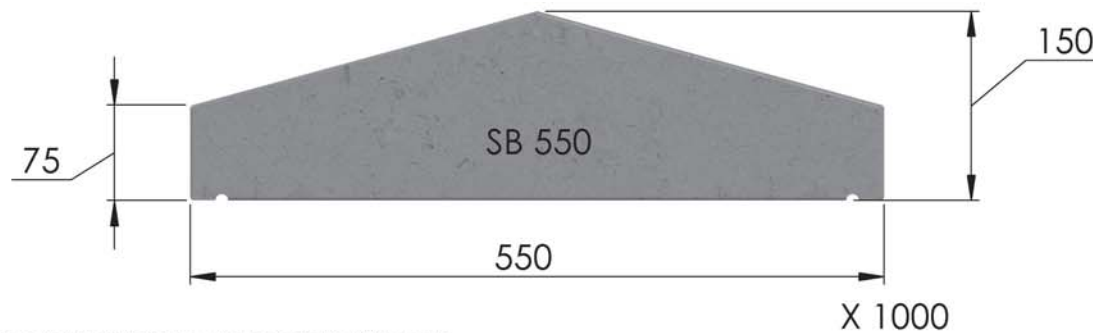
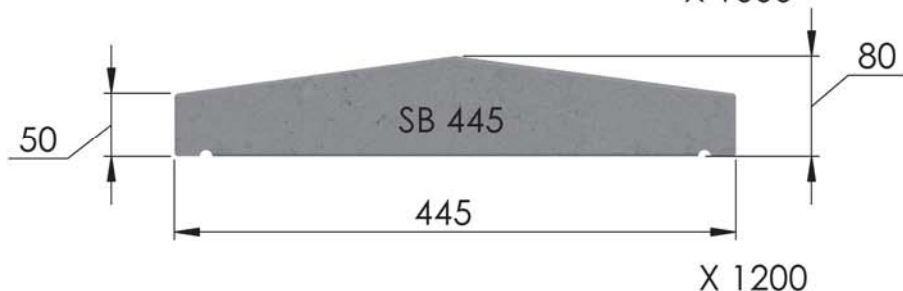
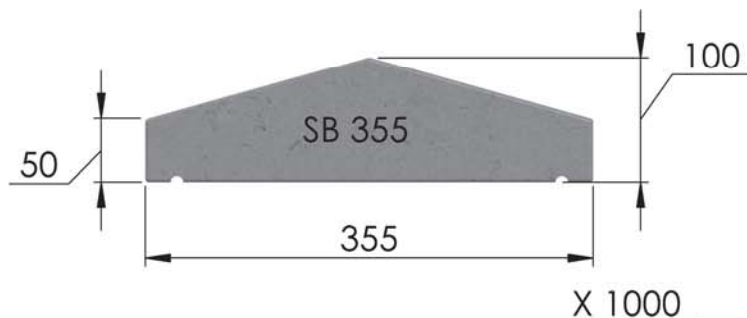
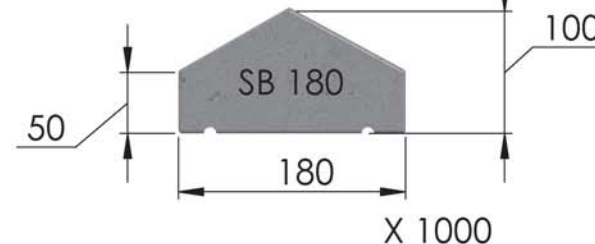
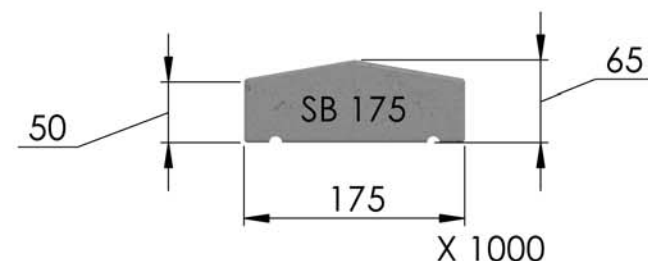
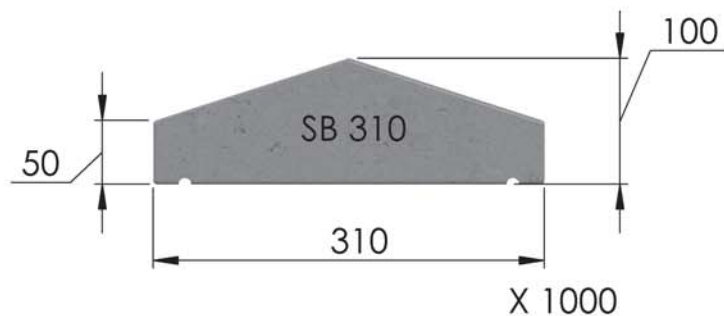

All dimensions are in millimetres. For non listed sizes please contact InGranite Recon LTD.

All vertical faces typically have a 4mm taper per 100mm of height.

The information contained in this drawing was correct at the time of going to print. Profiles, sizes and weights are given as indication only.



# InGranite Recon Ltd.

Reconstituted Stone | Modern Material | Classic Style

UK info@ingranite.co.uk

www.ingranite.co.uk

0808 2349118

RoI info@ingranite.ie

www.ingranite.ie

057 9331462

## Technical specification sheet

Title: Saddle back 175

Date: 27/02/2017 Ref: SB175

Scale: 1:6 Drawn by: InGranite

Approximate weight: 24 kgs

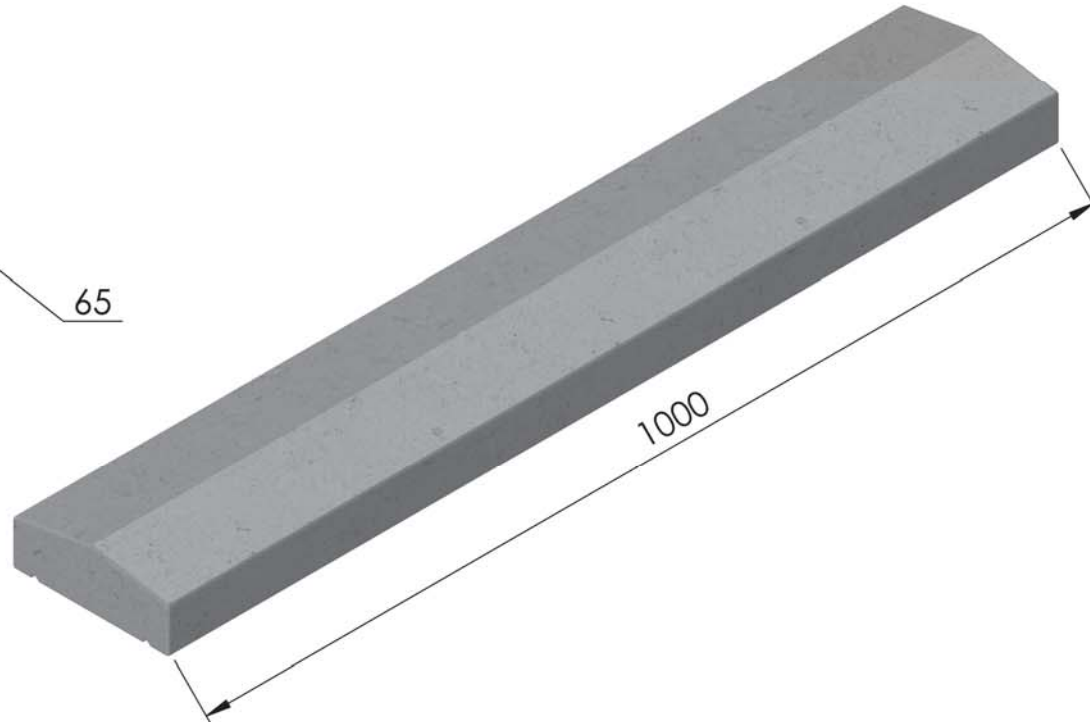
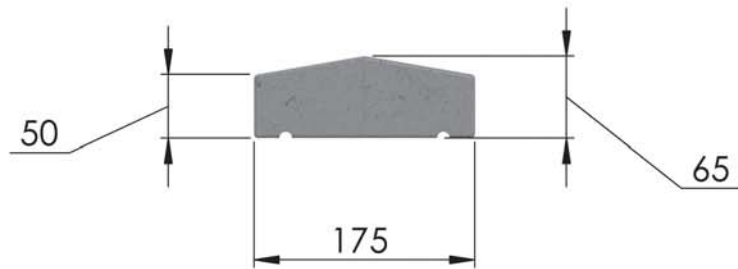
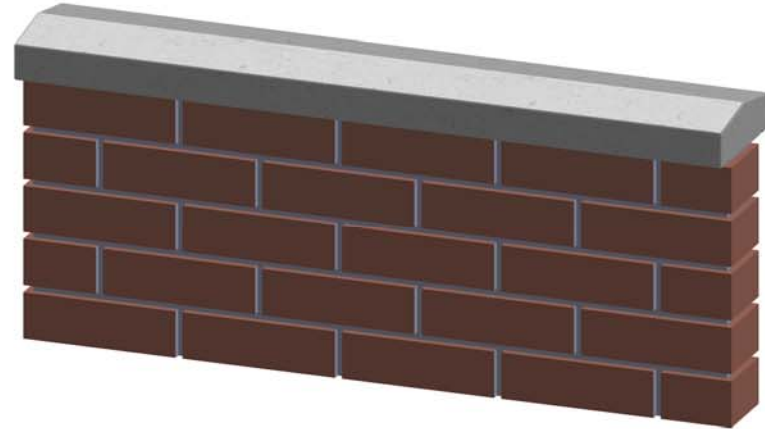

All dimensions are in millimetres. For non listed sizes please contact InGranite Recon LTD.

All vertical faces typically have a 4mm taper per 100mm of height.

The information contained in this drawing was correct at the time of going to print. Profiles, sizes and weights are given as indication only.



# InGranite Recon Ltd.

Reconstituted Stone | Modern Material | Classic Style

UK info@ingranite.co.uk

www.ingranite.co.uk

0808 2349118

RoI info@ingranite.ie

www.ingranite.ie

057 9331462

## Technical specification sheet

Title: Saddle back 180

Date: 27/02/2017

Ref: SB 180

Scale: 1:6

Drawn by: InGranite

Approximate weight: 24 kgs

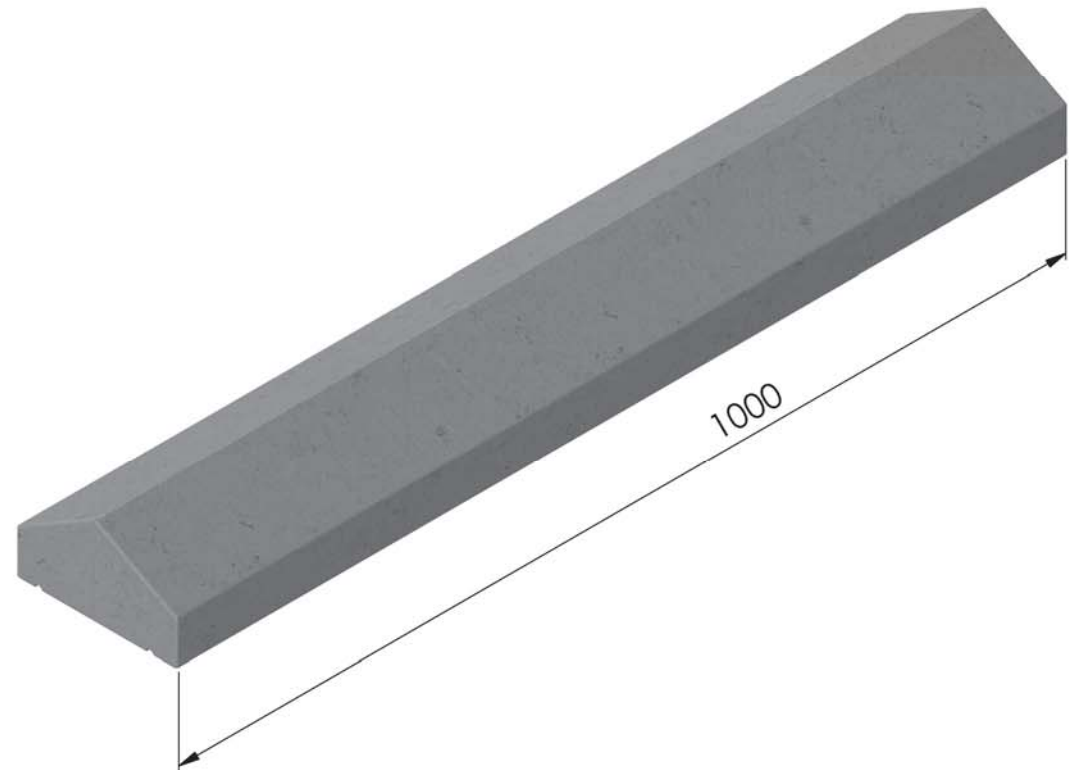
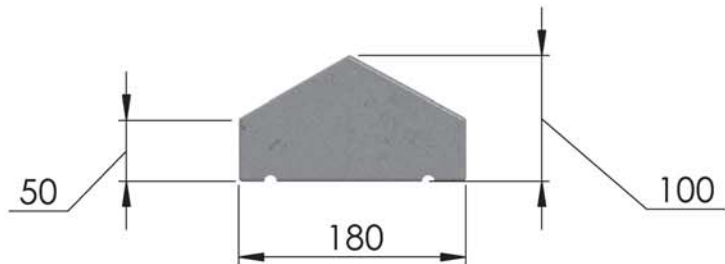
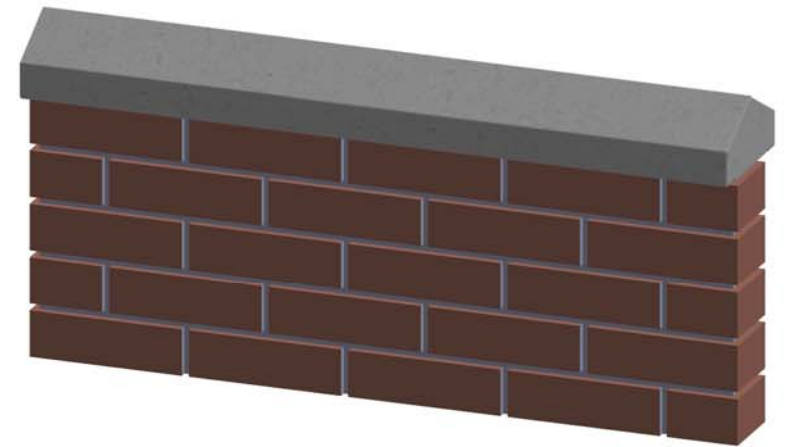

All dimensions are in millimetres. For non listed sizes please contact InGranite Recon LTD.

All vertical faces typically have a 4mm taper per 100mm of height.

The information contained in this drawing was correct at the time of going to print. Profiles, sizes and weights are given as indication only.



# InGranite Recon Ltd.

Reconstituted Stone | Modern Material | Classic Style

UK info@ingranite.co.uk

www.ingranite.co.uk

0808 2349118

RoI info@ingranite.ie

www.ingranite.ie

057 9331462

## Technical specification sheet

Title: Saddle back 310

Date: 23/02/2017

Ref: SB 310

Scale: 1:8

Drawn by: InGranite

Approximate weight:

56kgs/meter

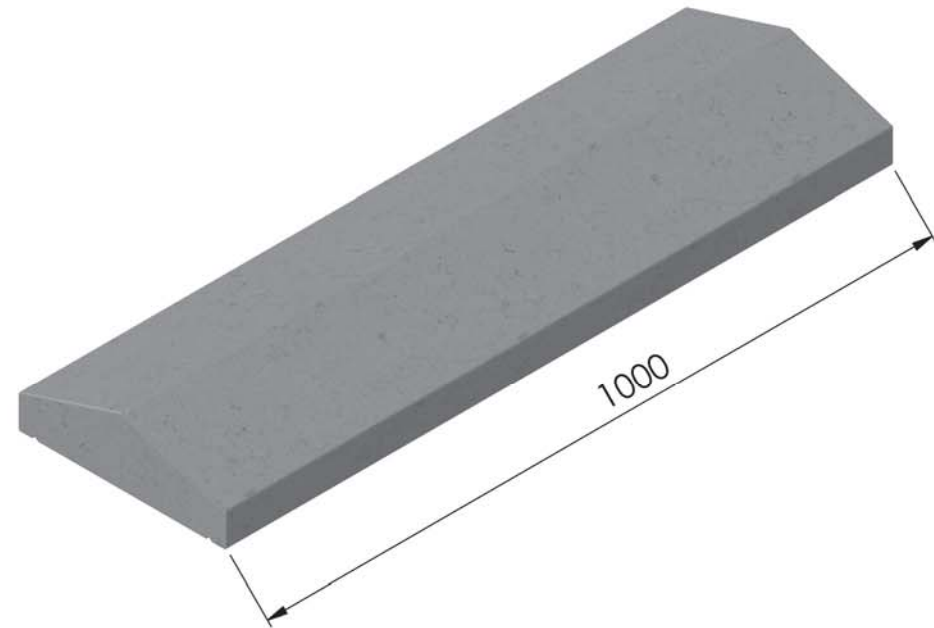
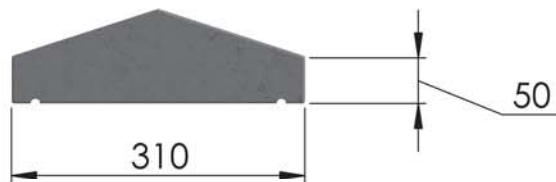
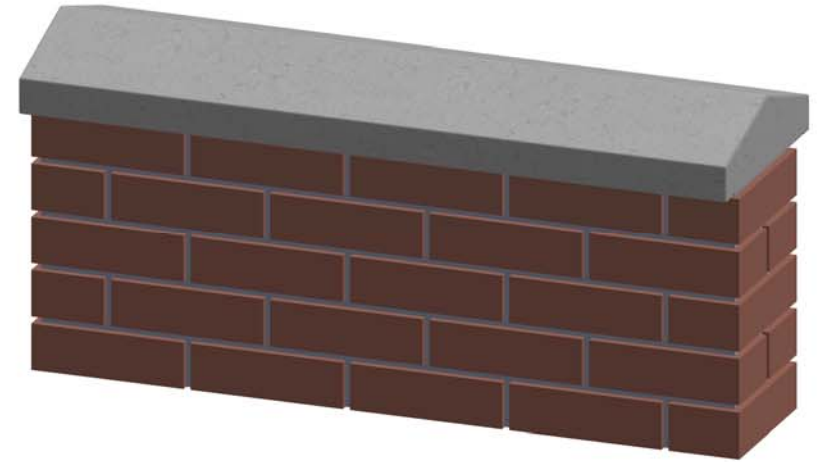

All dimensions are in millimetres. For non listed sizes please contact InGranite Recon LTD.

All vertical faces typically have a 4mm taper per 100mm of height.

The information contained in this drawing was correct at the time of going to print. Profiles, sizes and weights are given as indication only.



# InGranite Recon Ltd.

Reconstituted Stone | Modern Material | Classic Style

UK info@ingranite.co.uk

www.ingranite.co.uk

0808 2349118

RoI info@ingranite.ie

www.ingranite.ie

057 9331462

## Technical specification sheet

Title: Saddle back 355

Date: 27/02/2017

Ref: SB 355

Scale: 1:10

Drawn by: InGranite

Approximate weight: 64kgs

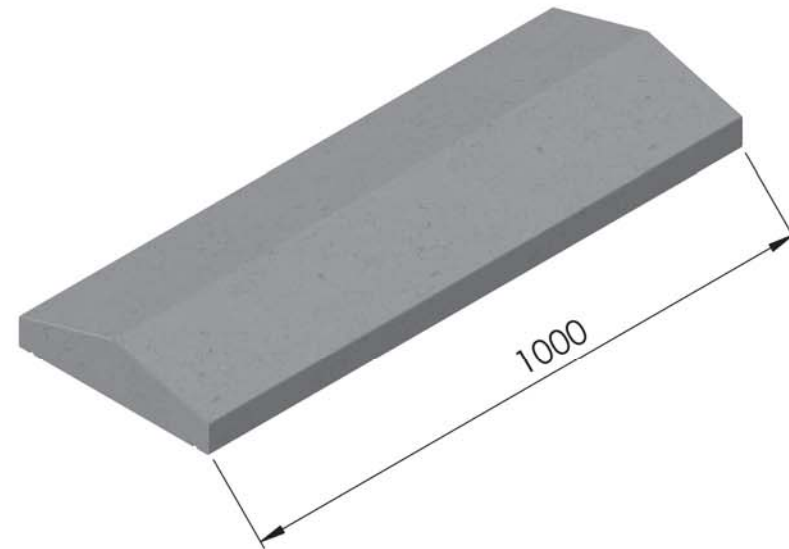
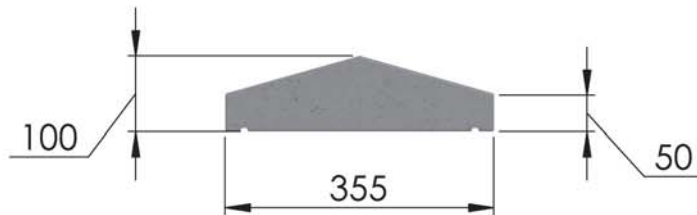
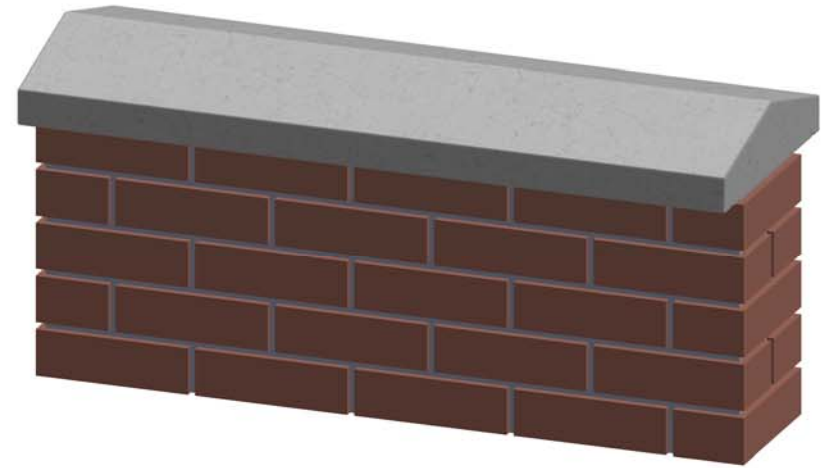

All dimensions are in millimetres. For non listed sizes please contact InGranite Recon LTD.

All vertical faces typically have a 4mm taper per 100mm of height.

The information contained in this drawing was correct at the time of going to print. Profiles, sizes and weights are given as indication only.



# InGranite Recon Ltd.

Reconstituted Stone | Modern Material | Classic Style

UK info@ingranite.co.uk

www.ingranite.co.uk

0808 2349118

RoI info@ingranite.ie

www.ingranite.ie

057 9331462

## Technical specification sheet

Title: Saddle back 420

Date: 27/02/2017

Ref: SB 420

Scale: 1:10

Drawn by: InGranite

Approximate weight: 121kgs

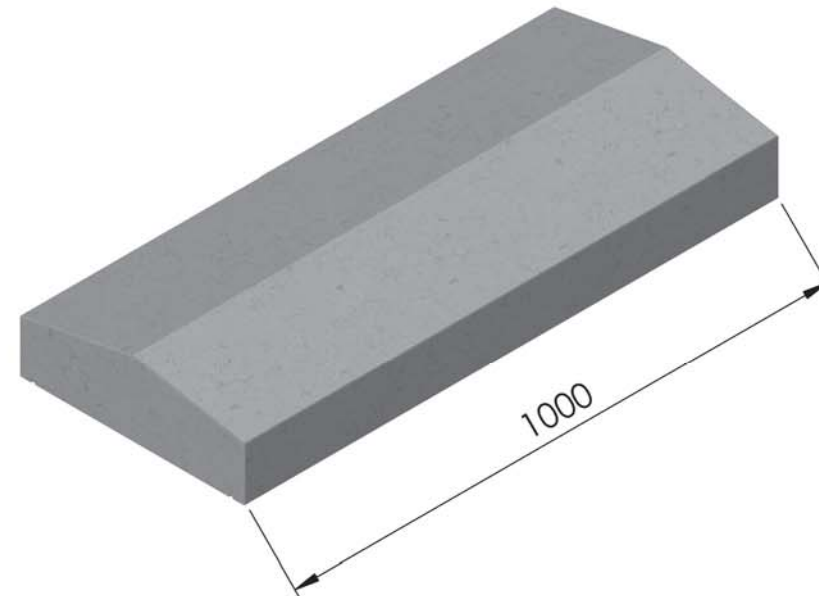
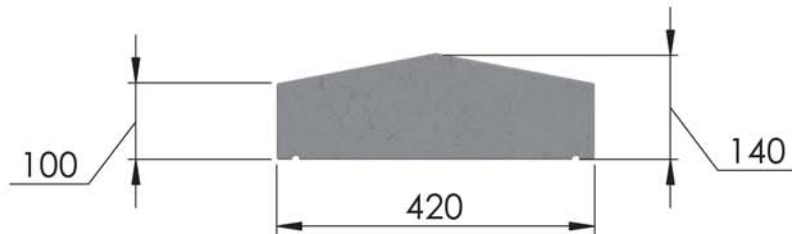
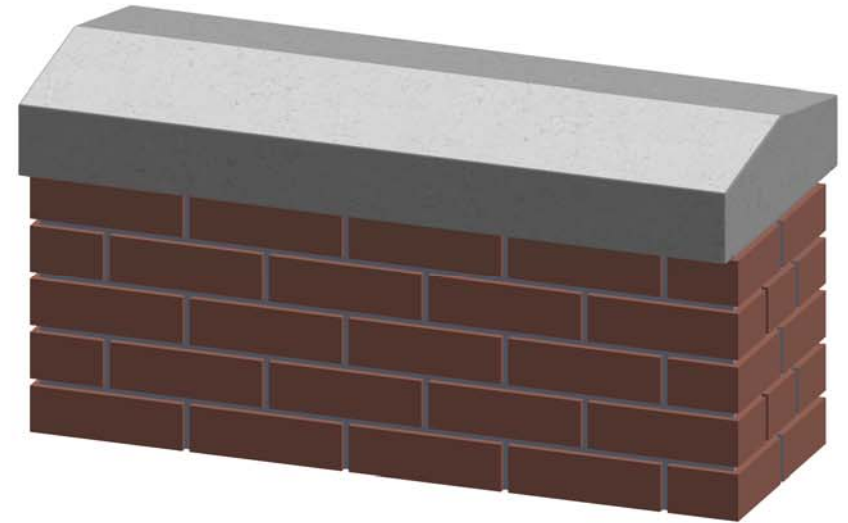

All dimensions are in millimetres. For non listed sizes please contact InGranite Recon LTD.

All vertical faces typically have a 4mm taper per 100mm of height.

The information contained in this drawing was correct at the time of going to print. Profiles, sizes and weights are given as indication only.



# InGranite Recon Ltd.

Reconstituted Stone | Modern Material | Classic Style

UK info@ingranite.co.uk

www.ingranite.co.uk

0808 2349118

RoI info@ingranite.ie

www.ingranite.ie

057 9331462

## Technical specification sheet

Title:	Saddle back 445		
Date:	27/02/2017	Ref:	SB 445
Scale:	1:10	Drawn by:	InGranite
Approximate weight:	83kgs		

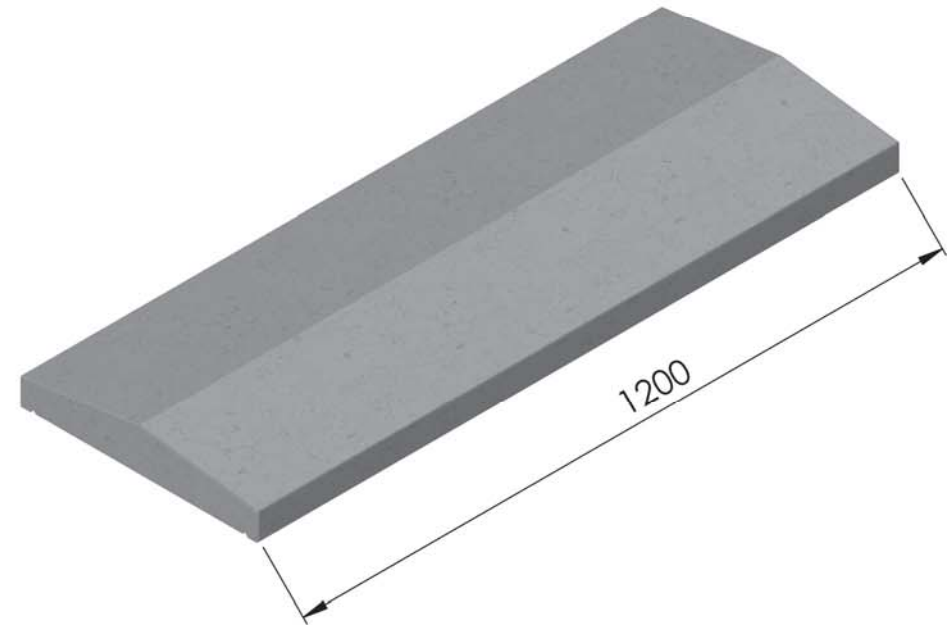
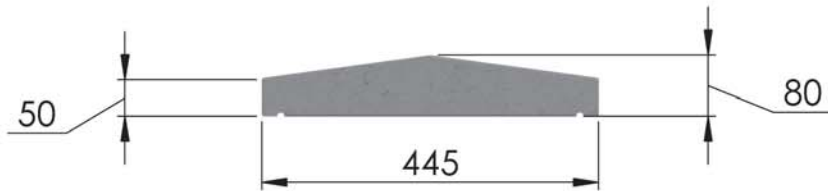
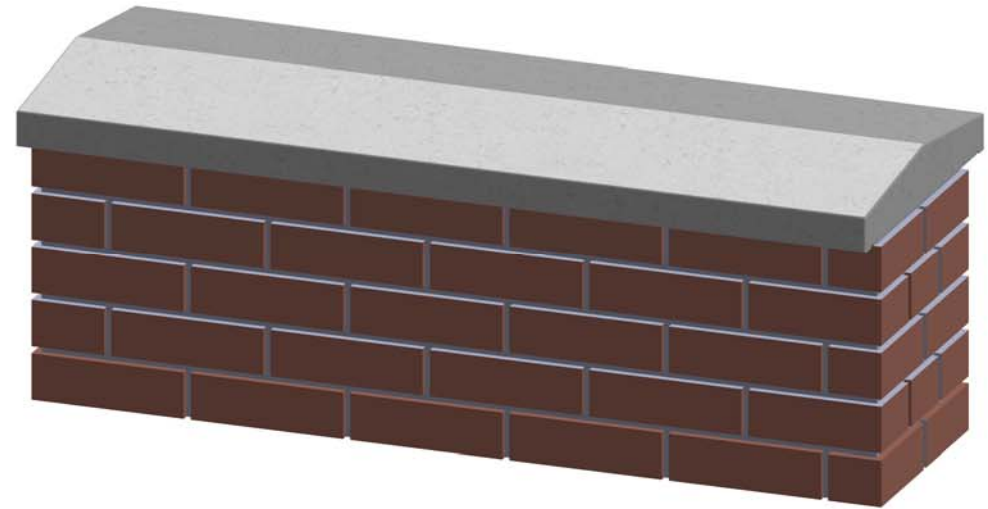

All dimensions are in millimetres. For non listed sizes please contact InGranite Recon LTD.

All vertical faces typically have a 4mm taper per 100mm of height.

The information contained in this drawing was correct at the time of going to print. Profiles, sizes and weights are given as indication only.





# InGranite Recon Ltd.

Reconstituted Stone | Modern Material | Classic Style

UK info@ingranite.co.uk

www.ingranite.co.uk

0808 2349118

RoI info@ingranite.ie

www.ingranite.ie

057 9331462

## Technical specification sheet

Title: Saddle back 550

Date: 27/02/2017

Ref: SB 550

Scale: 1:10

Drawn by: InGranite

Approximate weight: 148.5kgs

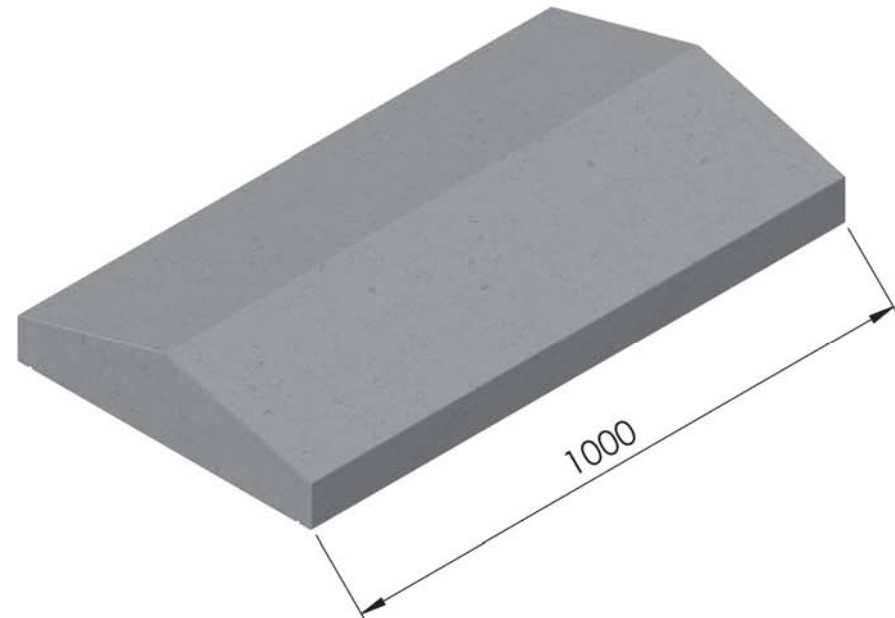
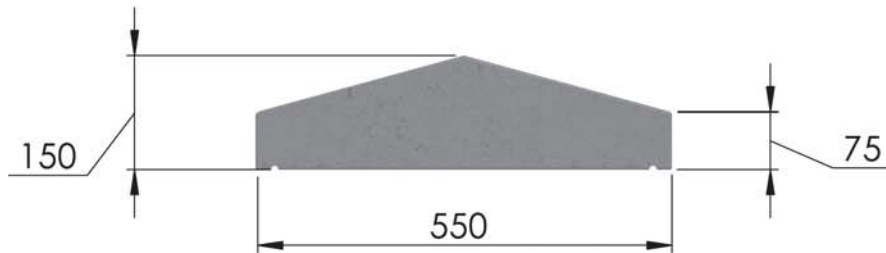
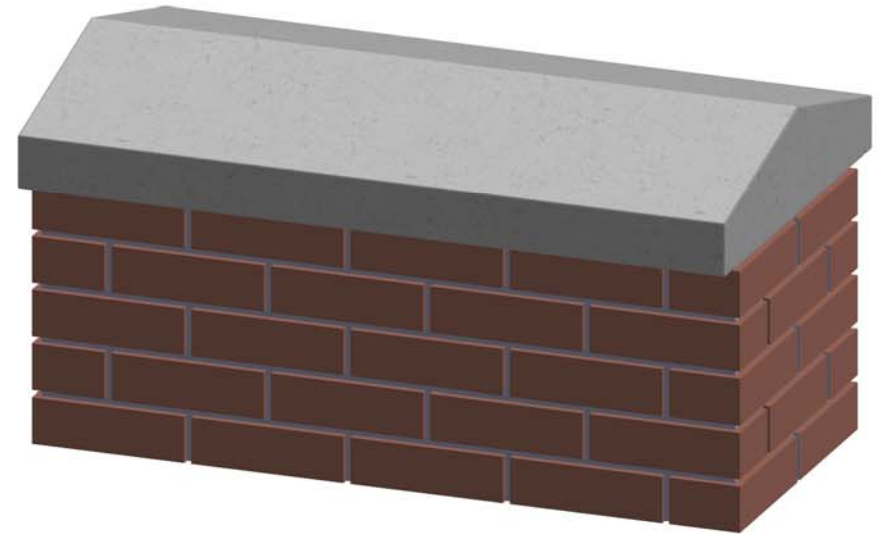

All dimensions are in millimetres. For non listed sizes please contact InGranite Recon LTD.

All vertical faces typically have a 4mm taper per 100mm of height.

The information contained in this drawing was correct at the time of going to print. Profiles, sizes and weights are given as indication only.



# InGranite Recon Ltd.

Reconstituted Stone | Modern Material | Classic Style

UK info@ingranite.co.uk

www.ingranite.co.uk

0808 2349118

RoI info@ingranite.ie

www.ingranite.ie

057 9331462

## Technical specification sheet

Title: Flat top wall cap range

Date: 28/02/2017

Ref: FT.....

Scale: 1:10

Drawn by: InGranite

Approximate weight:

46kgs/135kgs

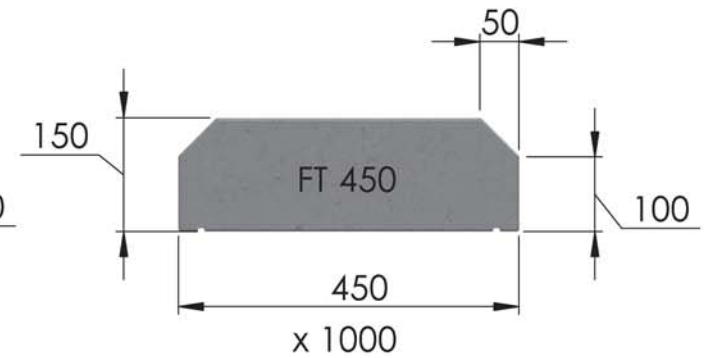
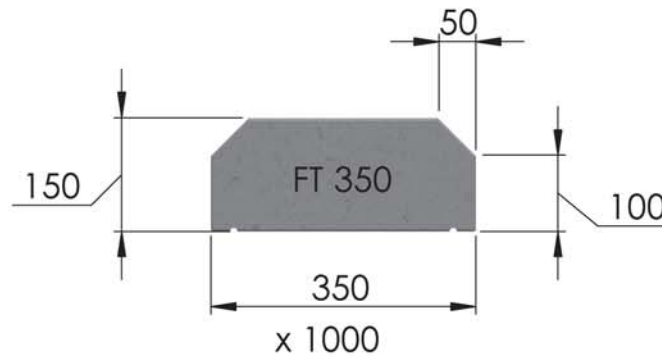
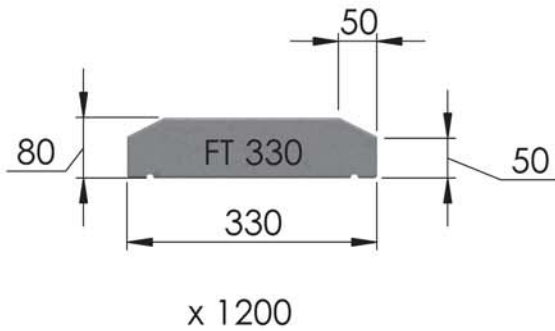
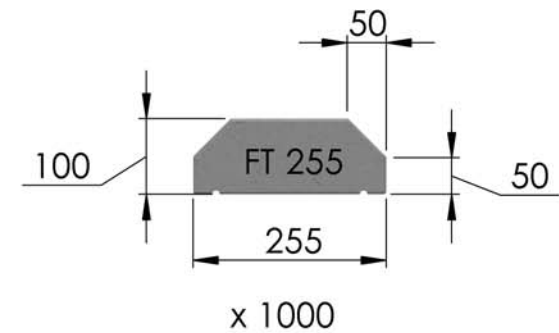
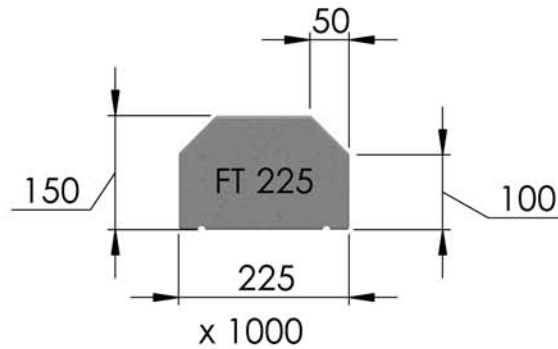

All dimensions are in millimetres. For non listed sizes please contact InGranite Recon LTD.

All vertical faces typically have a 4mm taper per 100mm of height.

The information contained in this drawing was correct at the time of going to print. Profiles, sizes and weights are given as indication only.



# InGranite Recon Ltd.

Reconstituted Stone | Modern Material | Classic Style

UK info@ingranite.co.uk

www.ingranite.co.uk

0808 2349118

RoI info@ingranite.ie

www.ingranite.ie

057 9331462

## Technical specification sheet

Title: 225 Flat top wall cap

Date: 27/02/2017

Ref: FT 225

Scale: 1:10

Drawn by: InGranite

Approximate weight: 67.5kgs

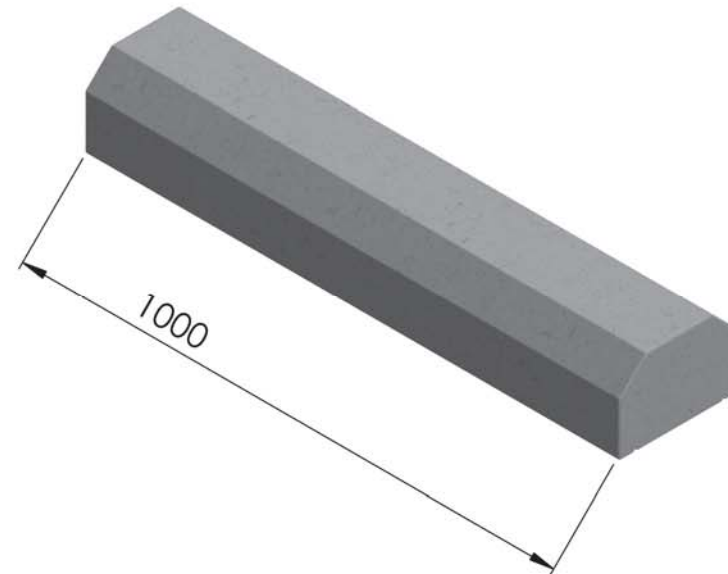
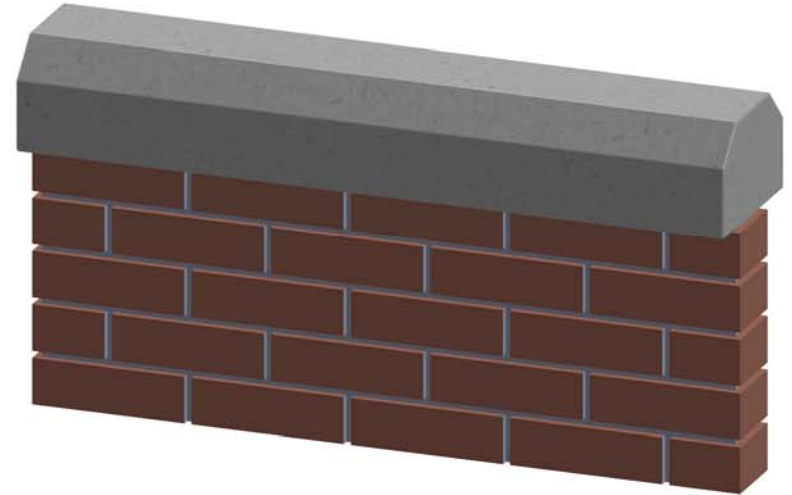
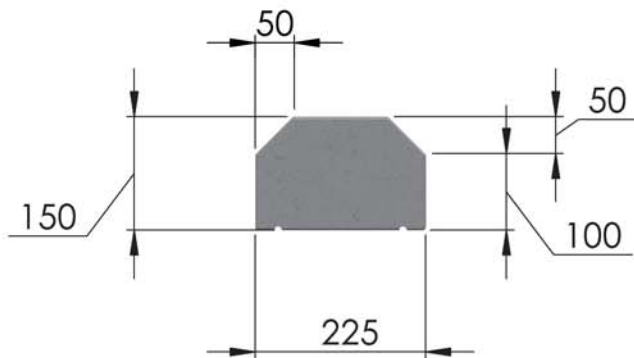

All dimensions are in millimetres. For non listed sizes please contact InGranite Recon LTD.

All vertical faces typically have a 4mm taper per 100mm of height.

The information contained in this drawing was correct at the time of going to print. Profiles, sizes and weights are given as indication only.



# InGranite Recon Ltd.

Reconstituted Stone | Modern Material | Classic Style

UK info@ingranite.co.uk

www.ingranite.co.uk

0808 2349118

RoI info@ingranite.ie

www.ingranite.ie

057 9331462

## Technical specification sheet

Title: 255 Flat top wall cap

Date: 27/02/2017

Ref: FT 255

Scale: 1:10

Drawn by: InGranite

Approximate weight: 46kgs

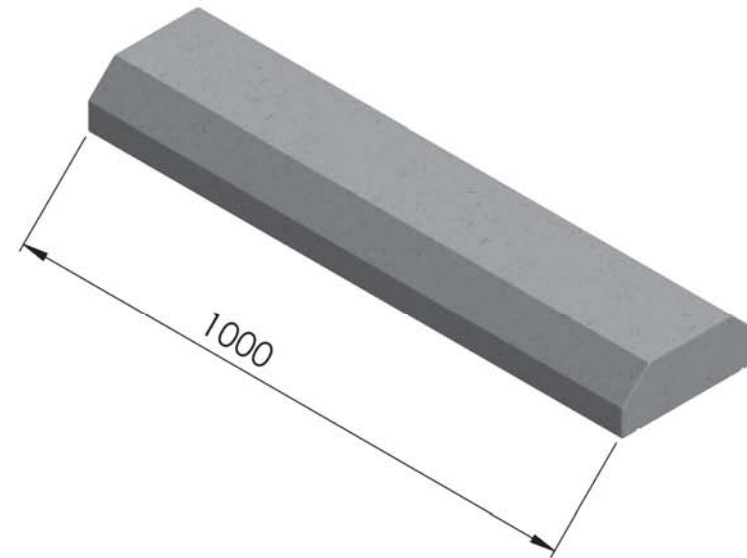
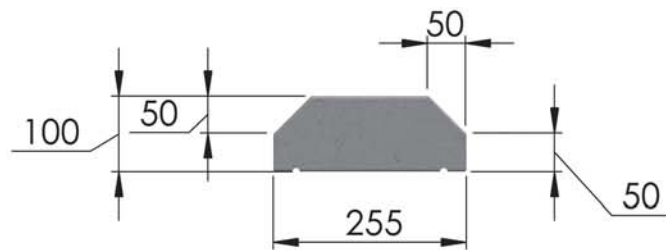
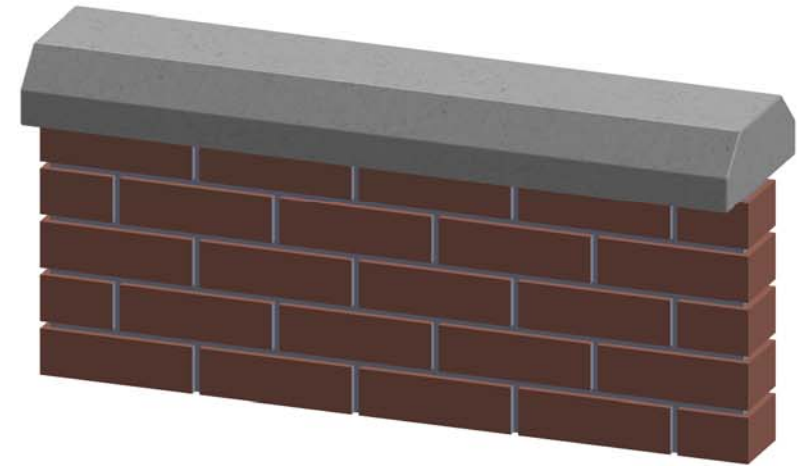

All dimensions are in millimetres. For non listed sizes please contact InGranite Recon LTD.

All vertical faces typically have a 4mm taper per 100mm of height.

The information contained in this drawing was correct at the time of going to print. Profiles, sizes and weights are given as indication only.



# InGranite Recon Ltd.

Reconstituted Stone | Modern Material | Classic Style

UK info@ingranite.co.uk

www.ingranite.co.uk

0808 2349118

RoI info@ingranite.ie

www.ingranite.ie

057 9331462

## Technical specification sheet

Title: 330 Flat top wall cap

Date: 27/02/2017

Ref: FT 330

Scale: 1:10

Drawn by: InGranite

Approximate weight:

64kgs

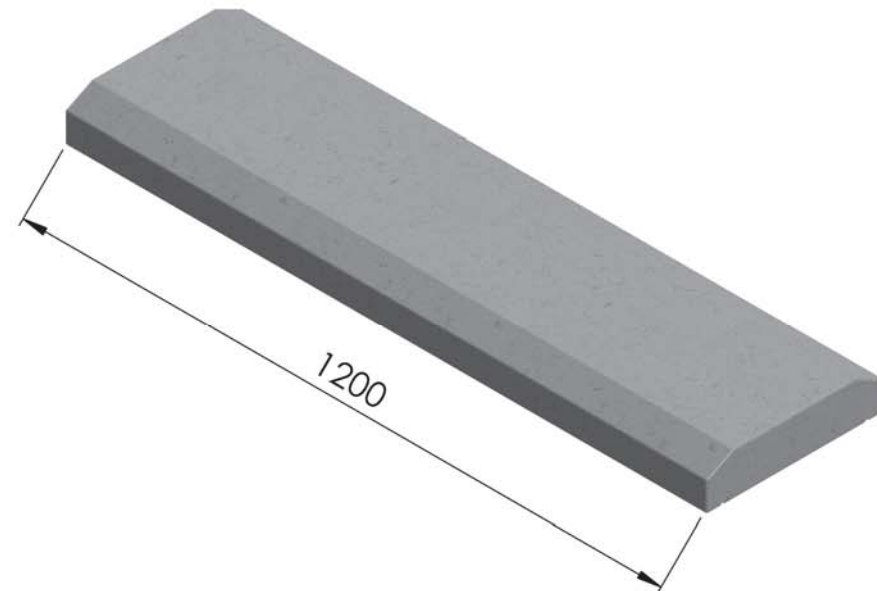
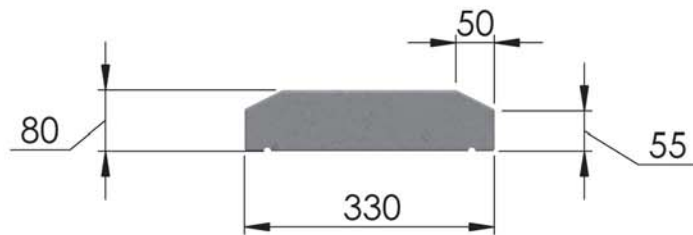
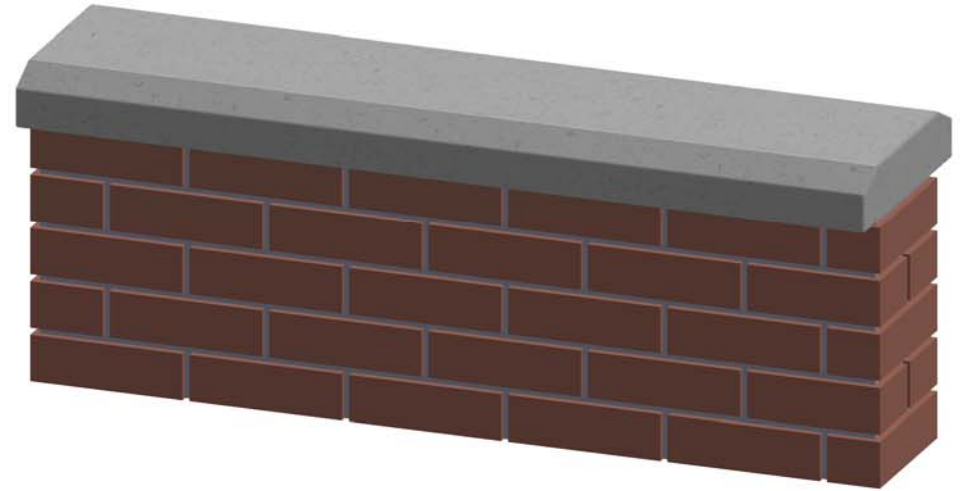

All dimensions are in millimetres. For non listed sizes please contact InGranite Recon LTD.

All vertical faces typically have a 4mm taper per 100mm of height.

The information contained in this drawing was correct at the time of going to print. Profiles, sizes and weights are given as indication only.



# InGranite Recon Ltd.

Reconstituted Stone | Modern Material | Classic Style

UK info@ingranite.co.uk

www.ingranite.co.uk

0808 2349118

RoI info@ingranite.ie

www.ingranite.ie

057 9331462

## Technical specification sheet

Title: 350 Flat top wall cap

Date: 27/02/2017

Ref: FT 350

Scale: 1:10

Drawn by: InGranite

Approximate weight: 105kgs

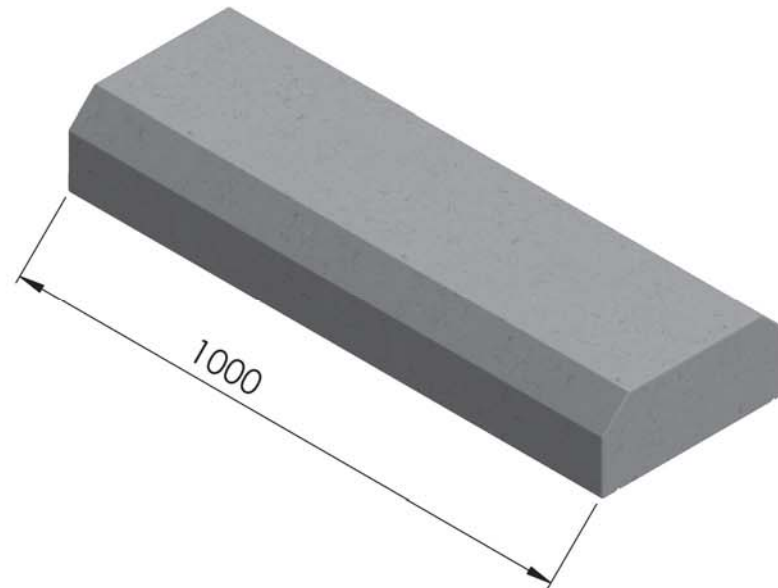
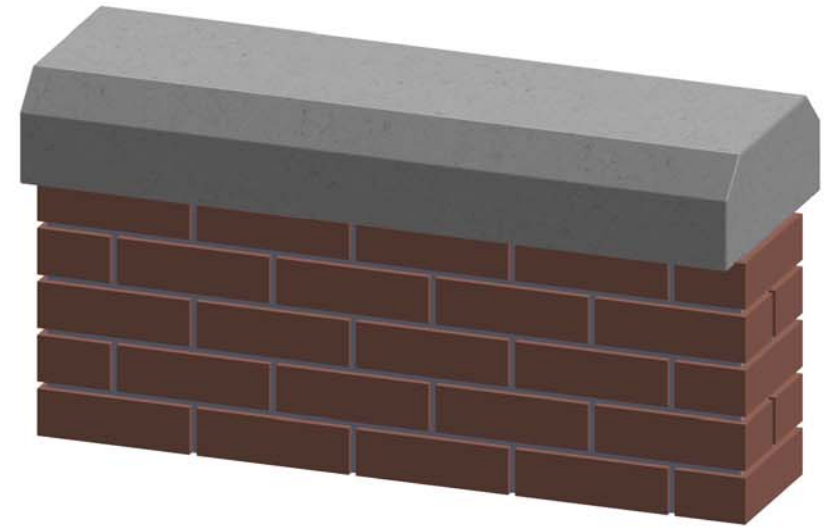
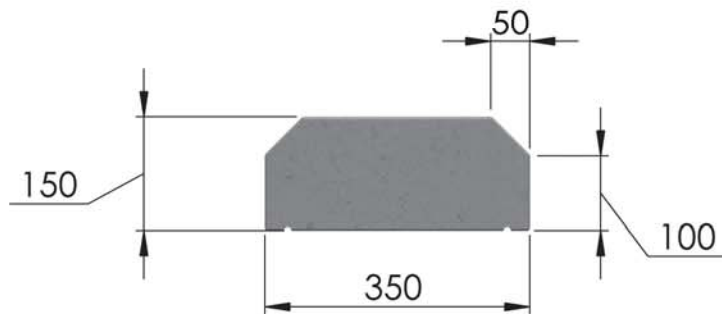

All dimensions are in millimetres. For non listed sizes please contact InGranite Recon LTD.

All vertical faces typically have a 4mm taper per 100mm of height.

The information contained in this drawing was correct at the time of going to print. Profiles, sizes and weights are given as indication only.



# InGranite Recon Ltd.

Reconstituted Stone | Modern Material | Classic Style

UK info@ingranite.co.uk

RoI info@ingranite.ie

www.ingranite.co.uk

www.ingranite.ie

0808 2349118

057 9331462

## Technical specification sheet

Title: 450 Flat top wall cap

Date: 28/02/2017

Ref: FT 450

Scale: 1:10

Drawn by: InGranite

Approximate weight: 135kgs

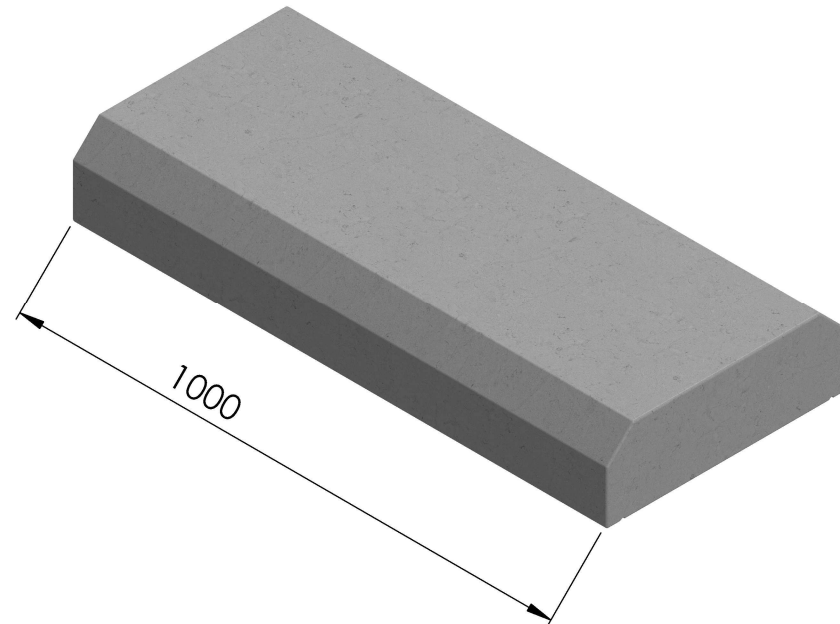
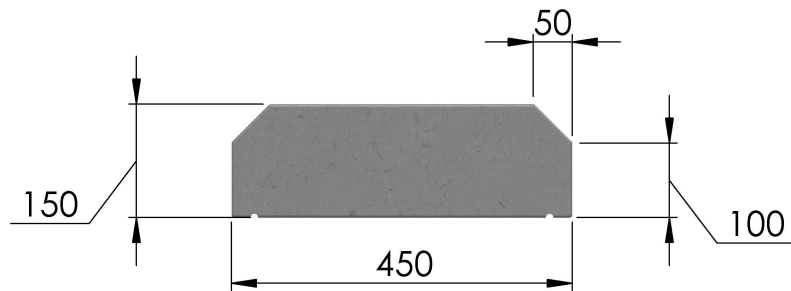
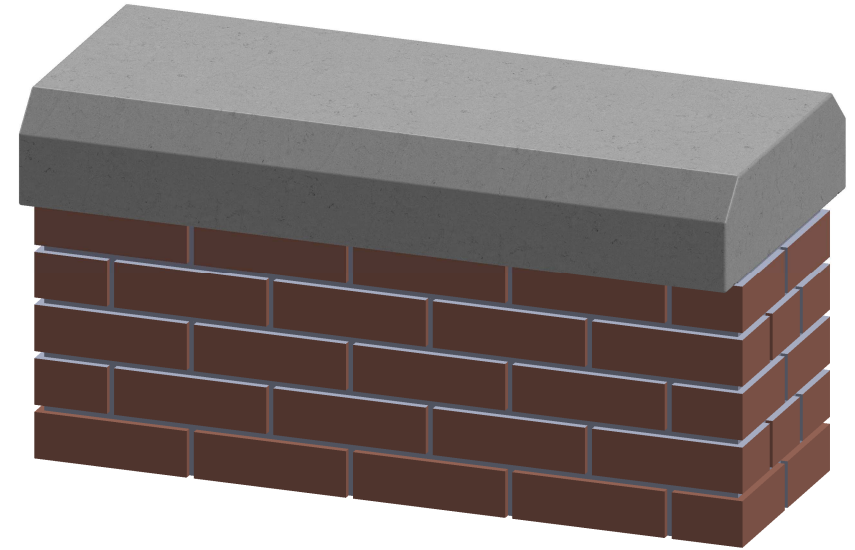

All dimensions are in millimetres. For non listed sizes please contact InGranite Recon LTD.

All vertical faces typically have a 4mm taper per 100mm of height.

The information contained in this drawing was correct at the time of going to print. Profiles, sizes and weights are given as indication only.



# InGranite Recon Ltd.

Reconstituted Stone | Modern Material | Classic Style

UK info@ingranite.co.uk

www.ingranite.co.uk

0808 2349118

RoI info@ingranite.ie

www.ingranite.ie

057 9331462

## Technical specification sheet

Title: Flat wall cap range

Date: 28/02/2017

Ref: FL .....

Scale: 1:10

Drawn by: InGranite

Approximate weight: 22.5kgs/132kgs

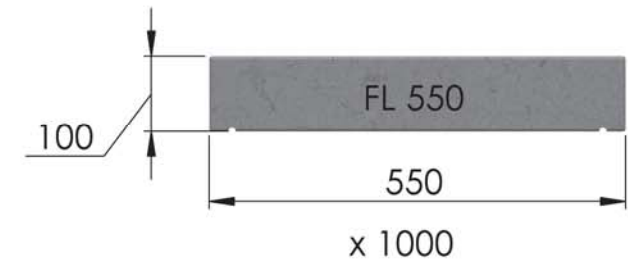
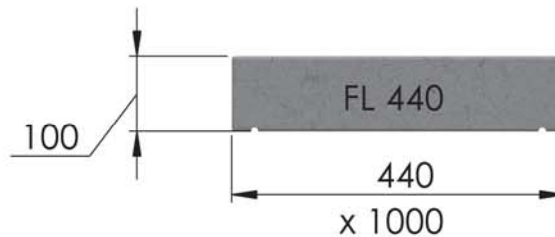
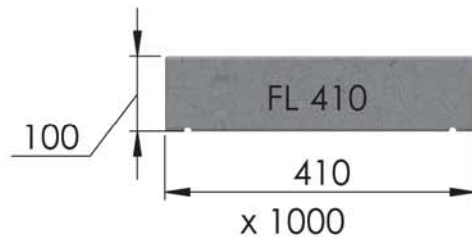
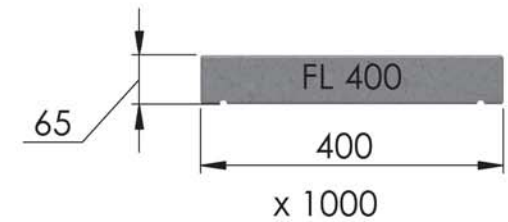
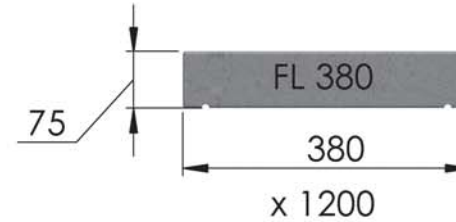
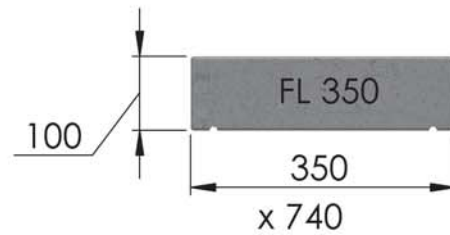
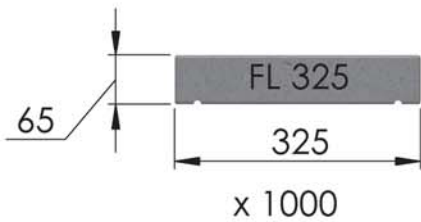
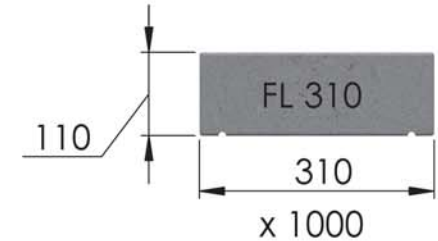
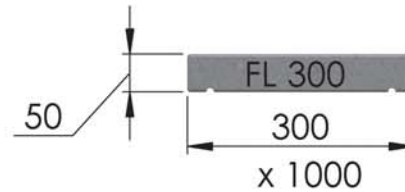
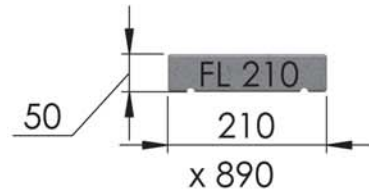

All dimensions are in millimetres. For non listed sizes please contact InGranite Recon LTD.

All vertical faces typically have a 4mm taper per 100mm of height.

The information contained in this drawing was correct at the time of going to print. Profiles, sizes and weights are given as indication only.





# InGranite Recon Ltd.

Reconstituted Stone | Modern Material | Classic Style

UK info@ingranite.co.uk

www.ingranite.co.uk

0808 2349118

RoI info@ingranite.ie

www.ingranite.ie

057 9331462

## Technical specification sheet

Title: 210 Flat wall cap

Date: 28/02/2017

Ref: FL 210

Scale: 1:5

Drawn by: InGranite

Approximate weight:

22kgs

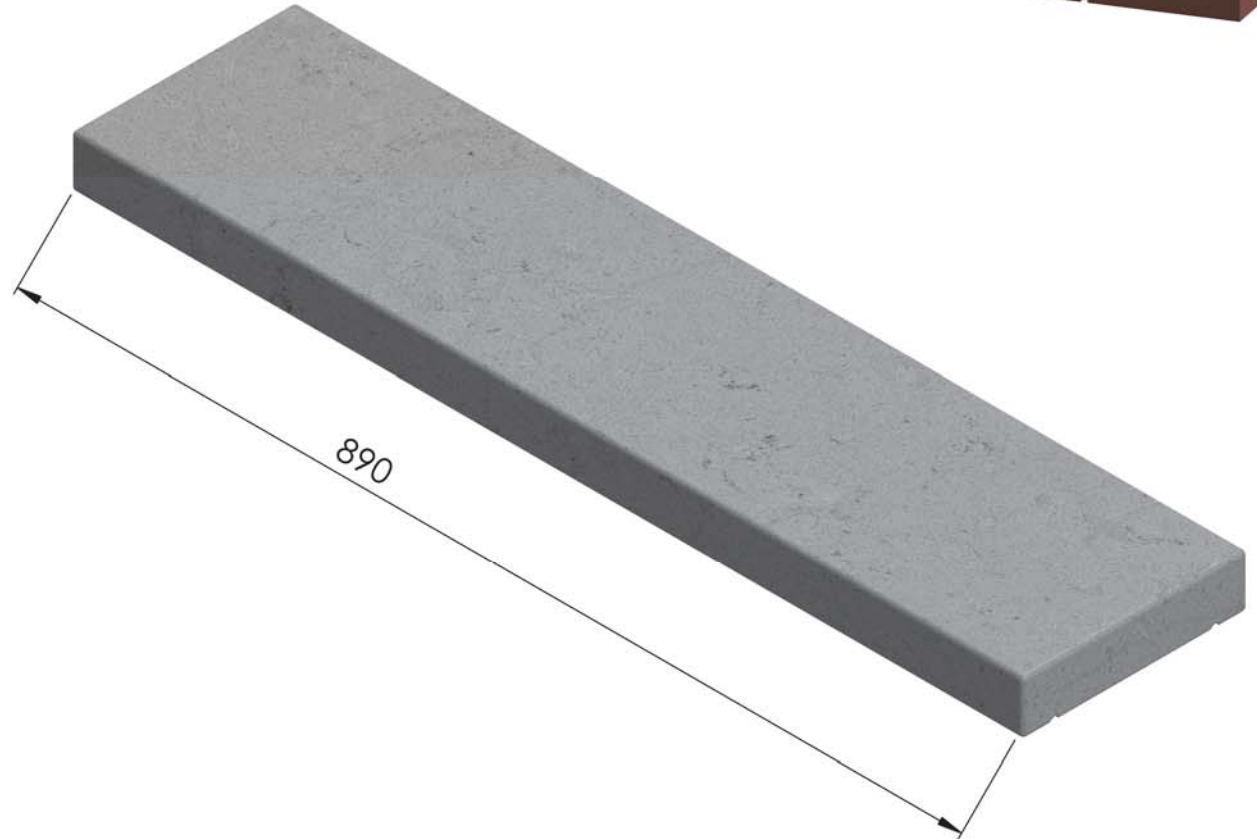
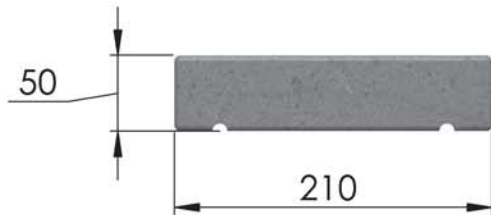

All dimensions are in millimetres. For non listed sizes please contact InGranite Recon LTD.

All vertical faces typically have a 4mm taper per 100mm of height.

The information contained in this drawing was correct at the time of going to print. Profiles, sizes and weights are given as indication only.



# InGranite Recon Ltd.

Reconstituted Stone | Modern Material | Classic Style

UK info@ingranite.co.uk

www.ingranite.co.uk

0808 2349118

RoI info@ingranite.ie

www.ingranite.ie

057 9331462

## Technical specification sheet

Title: 300 Flat wall cap

Date: 28/02/2017

Ref: FL 300

Scale: 1:8

Drawn by: InGranite

Approximate weight: 36kgs

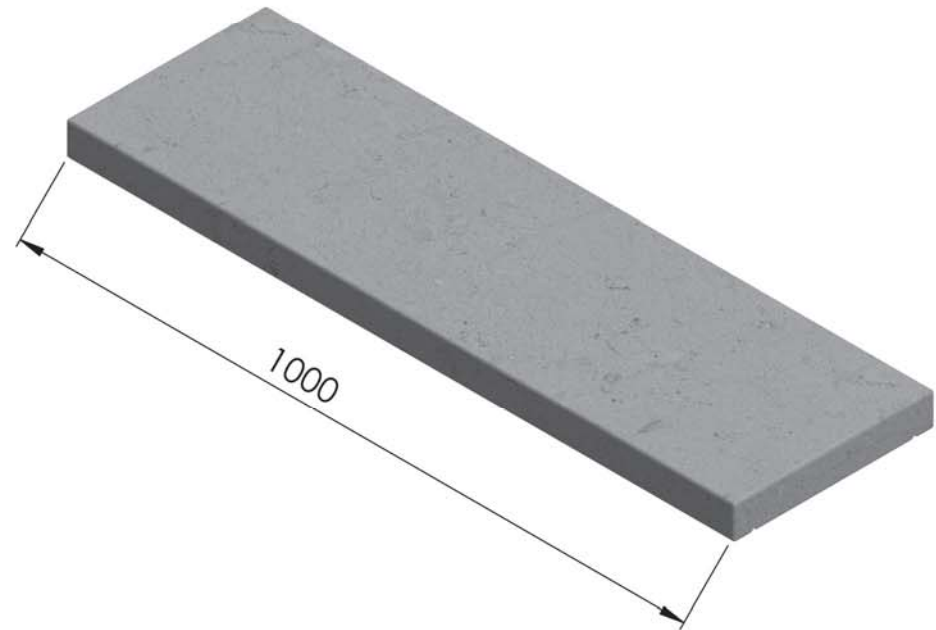
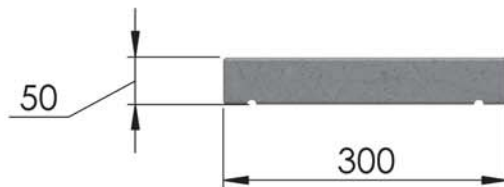
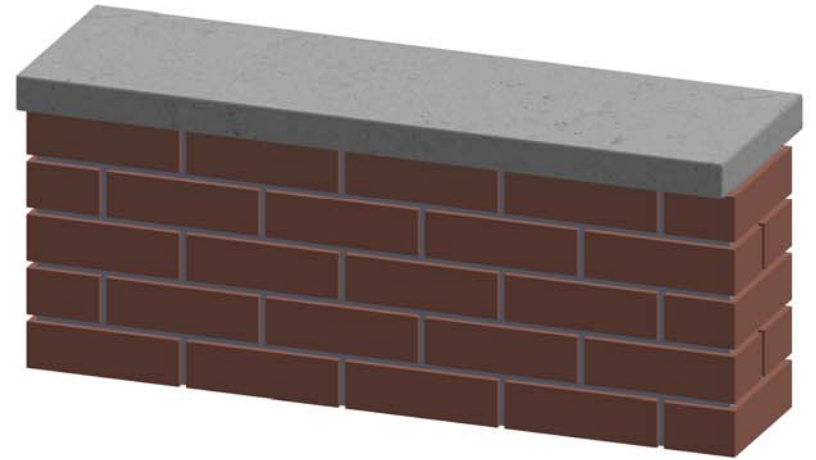

All dimensions are in millimetres. For non listed sizes please contact InGranite Recon LTD.

All vertical faces typically have a 4mm taper per 100mm of height.

The information contained in this drawing was correct at the time of going to print. Profiles, sizes and weights are given as indication only.



# InGranite Recon Ltd.

Reconstituted Stone | Modern Material | Classic Style

UK info@ingranite.co.uk

www.ingranite.co.uk

0808 2349118

RoI info@ingranite.ie

www.ingranite.ie

057 9331462

## Technical specification sheet

Title: 310 flat wall cap

Date: 28/02/2017

Ref: FL 310

Scale: 1:10

Drawn by: InGranite

Approximate weight:

82kgs

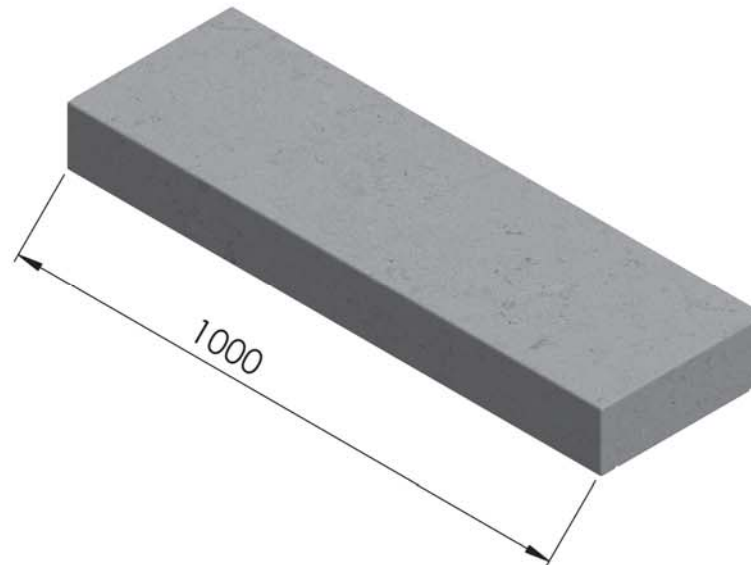
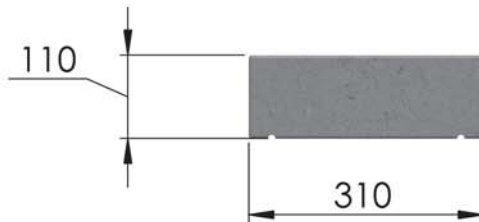
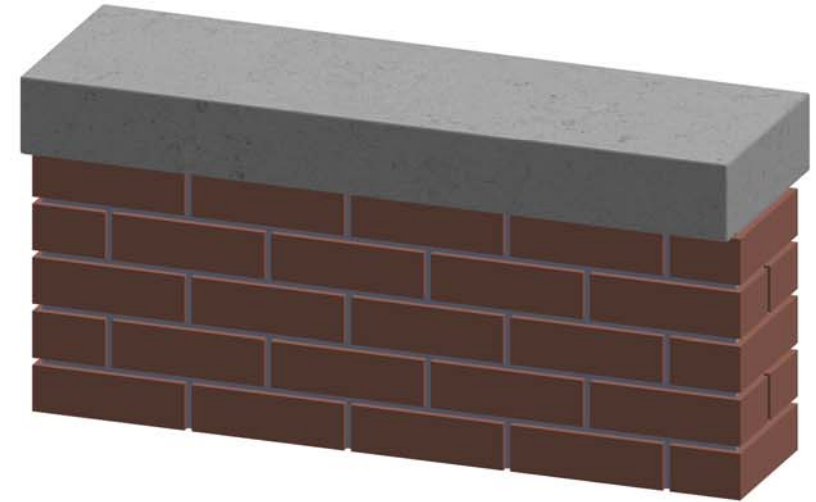

All dimensions are in millimetres. For non listed sizes please contact InGranite Recon LTD.

All vertical faces typically have a 4mm taper per 100mm of height.

The information contained in this drawing was correct at the time of going to print. Profiles, sizes and weights are given as indication only.



# InGranite Recon Ltd.

Reconstituted Stone | Modern Material | Classic Style

UK info@ingranite.co.uk

www.ingranite.co.uk

0808 2349118

RoI info@ingranite.ie

www.ingranite.ie

057 9331462

## Technical specification sheet

Title: 325 Flat wall cap

Date: 28/02/2017

Ref: FL 325

Scale: 1:10

Drawn by: InGranite

Approximate weight: 51kgs

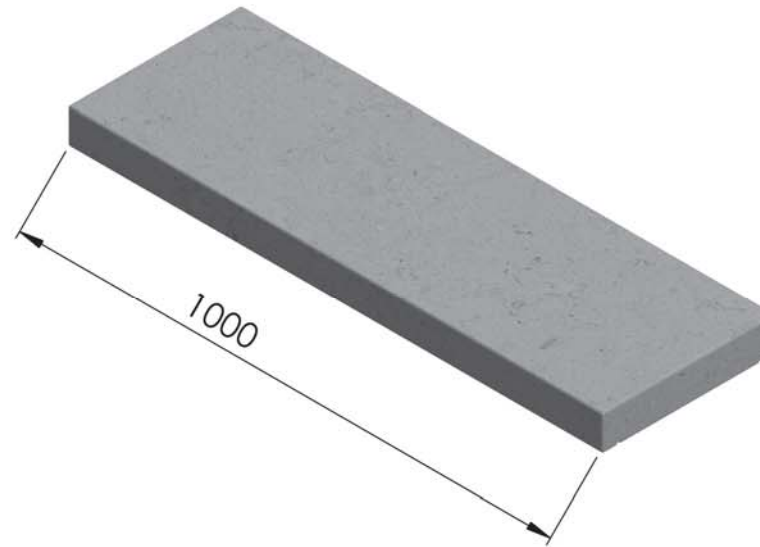
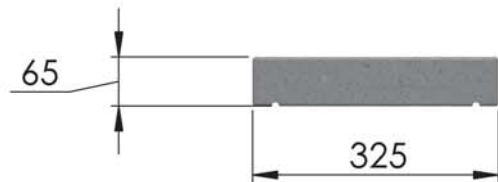
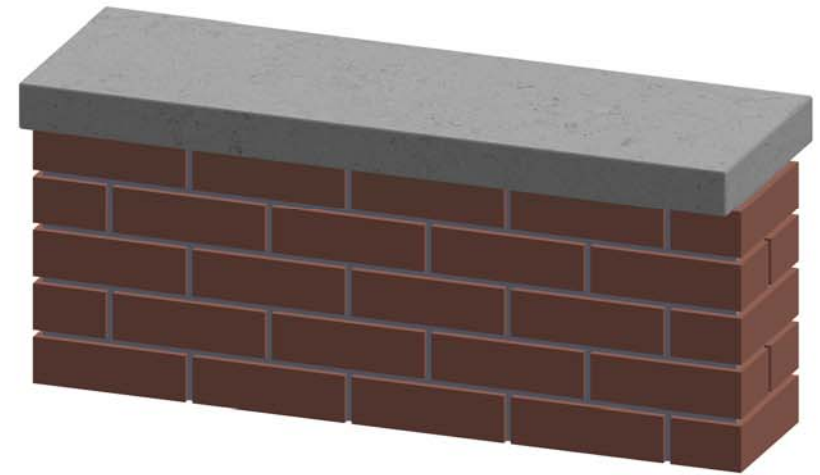

All dimensions are in millimetres. For non listed sizes please contact InGranite Recon LTD.

All vertical faces typically have a 4mm taper per 100mm of height.

The information contained in this drawing was correct at the time of going to print. Profiles, sizes and weights are given as indication only.



# InGranite Recon Ltd.

Reconstituted Stone | Modern Material | Classic Style

UK info@ingranite.co.uk

www.ingranite.co.uk

0808 2349118

RoI info@ingranite.ie

www.ingranite.ie

057 9331462

## Technical specification sheet

Title: 350 Flat wall cap

Date: 28/02/2017

Ref: FL 350

Scale: 1:10

Drawn by: InGranite

Approximate weight:

62kgs

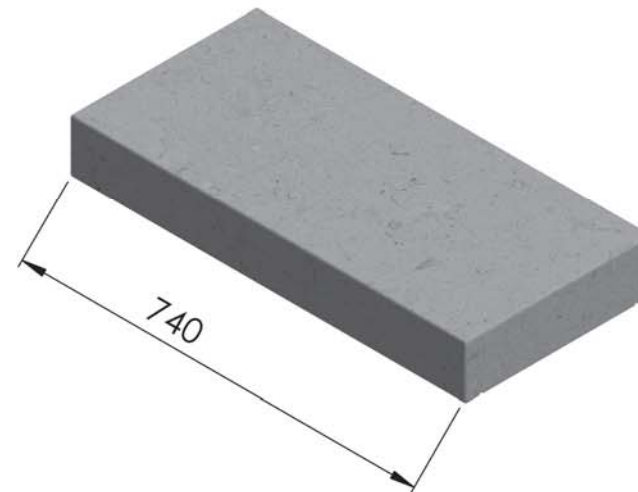
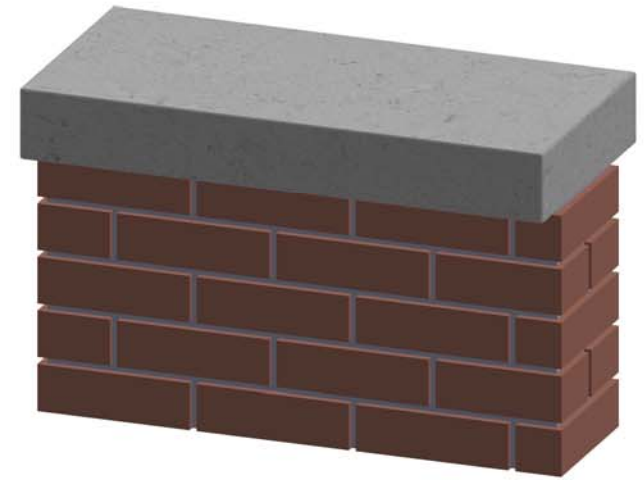
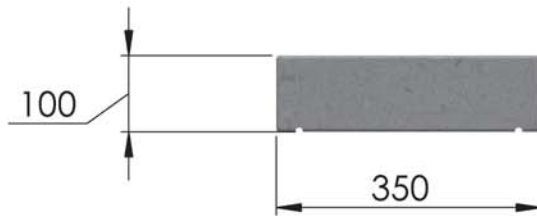

All dimensions are in millimetres. For non listed sizes please contact InGranite Recon LTD.

All vertical faces typically have a 4mm taper per 100mm of height.

The information contained in this drawing was correct at the time of going to print. Profiles, sizes and weights are given as indication only.



# InGranite Recon Ltd.

Reconstituted Stone | Modern Material | Classic Style

UK info@ingranite.co.uk

www.ingranite.co.uk

0808 2349118

RoI info@ingranite.ie

www.ingranite.ie

057 9331462

## Technical specification sheet

Title: 380 Flat wall cap

Date: 28/02/2017

Ref: FL 380

Scale: 1:10

Drawn by: InGranite

Approximate weight: 82kgs

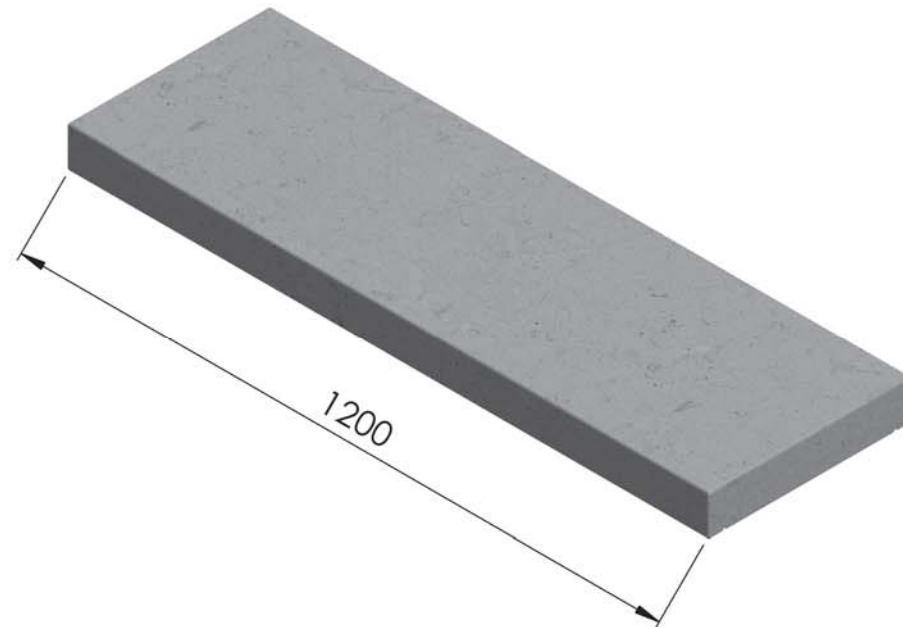
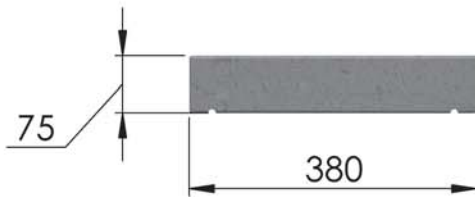
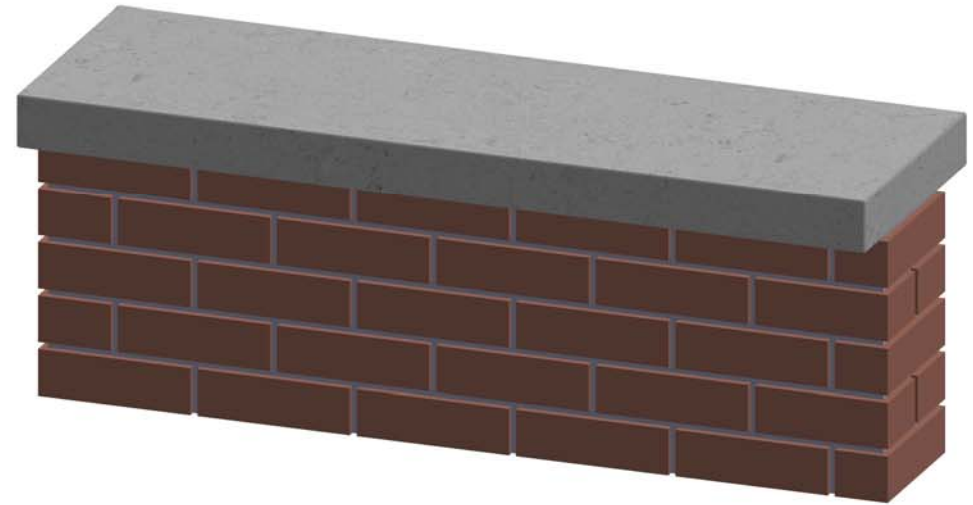

All dimensions are in millimetres. For non listed sizes please contact InGranite Recon LTD.

All vertical faces typically have a 4mm taper per 100mm of height.

The information contained in this drawing was correct at the time of going to print. Profiles, sizes and weights are given as indication only.



# InGranite Recon Ltd.

Reconstituted Stone | Modern Material | Classic Style

UK info@ingranite.co.uk

www.ingranite.co.uk

0808 2349118

RoI info@ingranite.ie

www.ingranite.ie

057 9331462

## Technical specification sheet

Title: 400 Flat wall cap

Date: 28/02/2017

Ref: FL 400

Scale: 1:10

Drawn by: InGranite

Approximate weight:

62.5 kgs

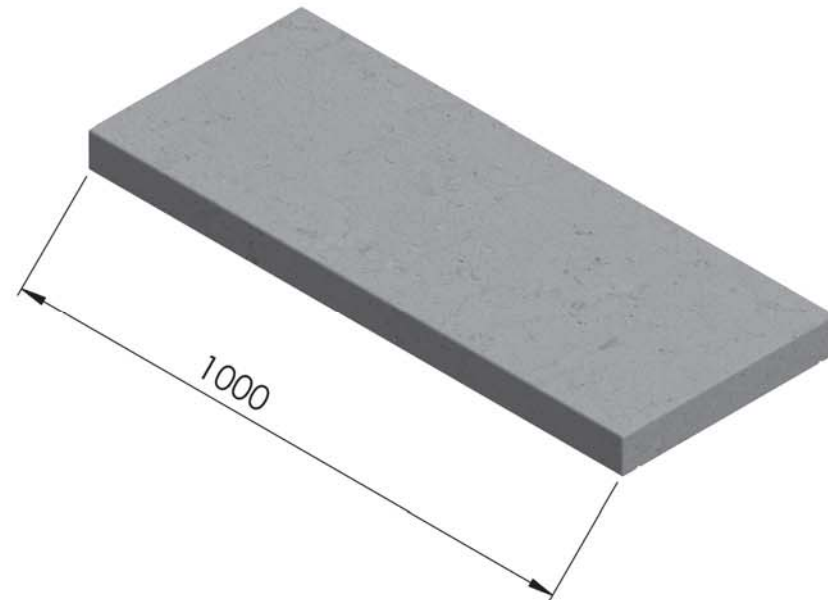
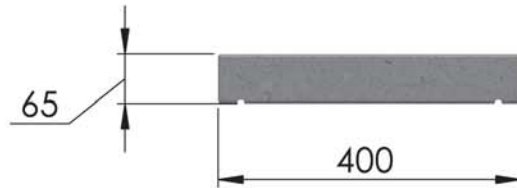
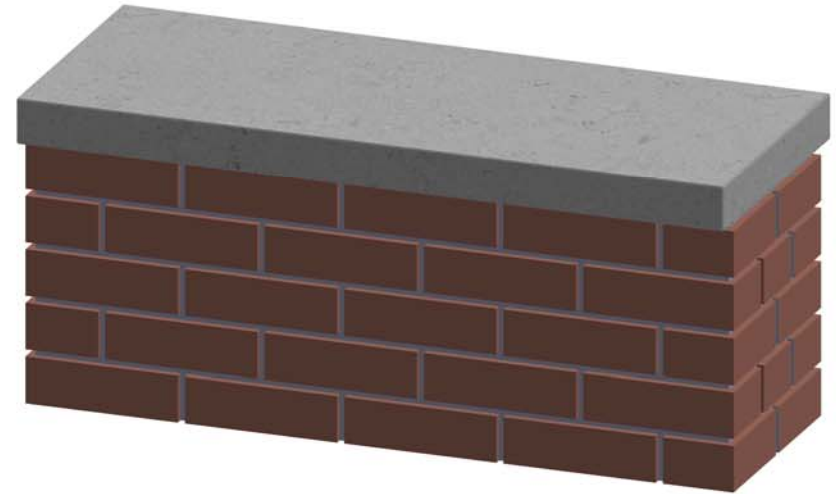

All dimensions are in millimetres. For non listed sizes please contact InGranite Recon LTD.

All vertical faces typically have a 4mm taper per 100mm of height.

The information contained in this drawing was correct at the time of going to print. Profiles, sizes and weights are given as indication only.



# InGranite Recon Ltd.

Reconstituted Stone | Modern Material | Classic Style

UK info@ingranite.co.uk

www.ingranite.co.uk

0808 2349118

RoI info@ingranite.ie

www.ingranite.ie

057 9331462

## Technical specification sheet

Title: 410 Flat wall cap

Date: 28/02/2017

Ref: FL 410

Scale: 1:10

Drawn by: InGranite

Approximate weight: 98.5kgs

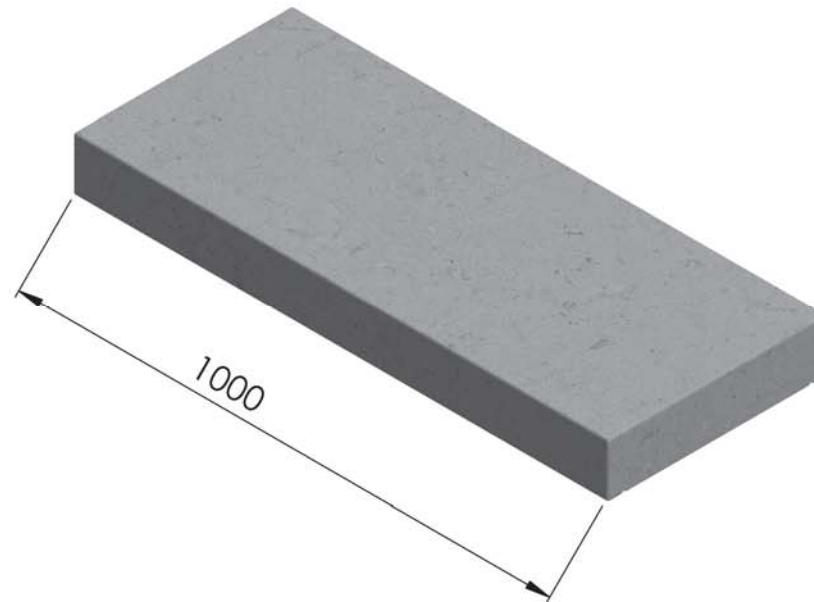
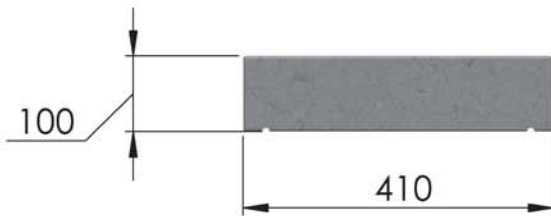
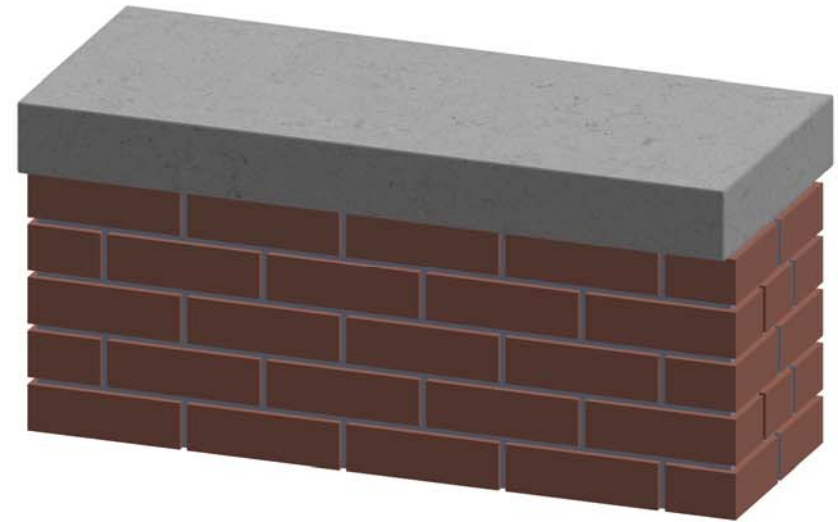

All dimensions are in millimetres. For non listed sizes please contact InGranite Recon LTD.

All vertical faces typically have a 4mm taper per 100mm of height.

The information contained in this drawing was correct at the time of going to print. Profiles, sizes and weights are given as indication only.





# InGranite Recon Ltd.

Reconstituted Stone | Modern Material | Classic Style

UK info@ingranite.co.uk

www.ingranite.co.uk

0808 2349118

RoI info@ingranite.ie

www.ingranite.ie

057 9331462

## Technical specification sheet

Title: 440 Flat wall cap

Date: 28/02/2017

Ref: FL 440

Scale: 1:10

Drawn by: InGranite

Approximate weight:

105.5kgs

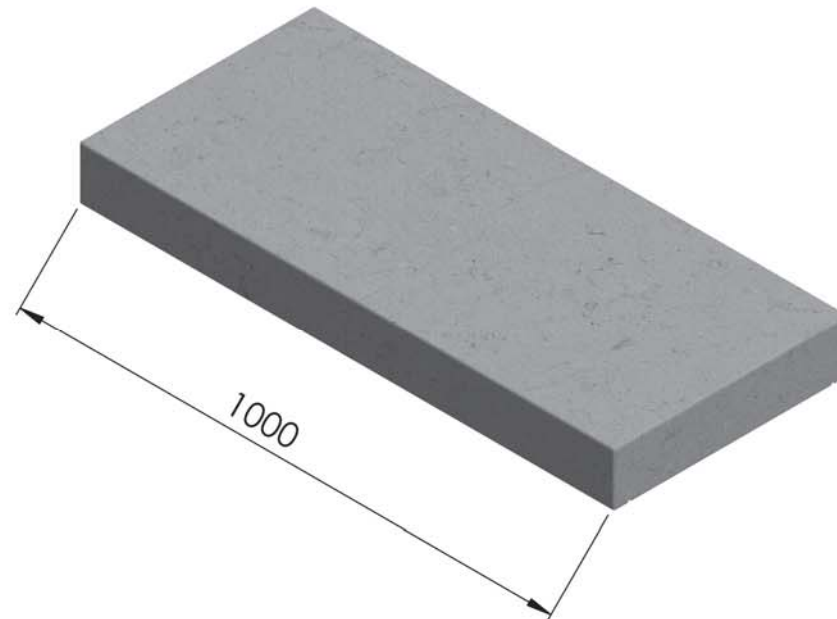
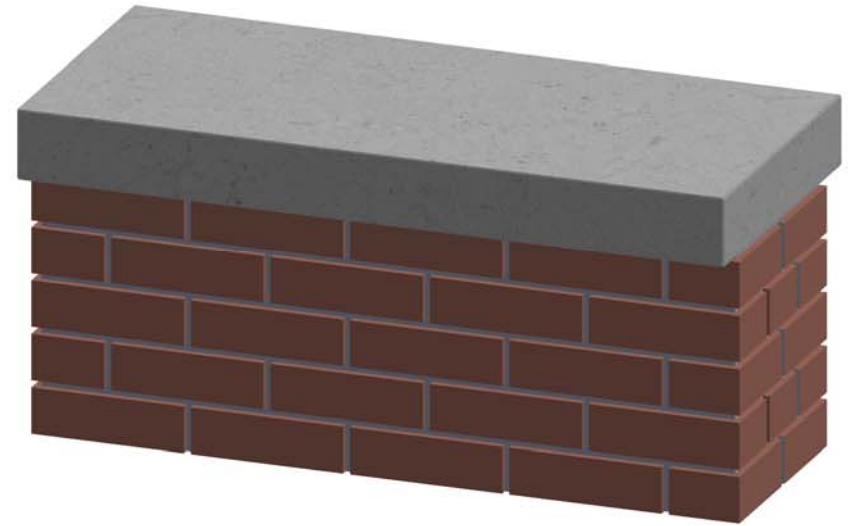
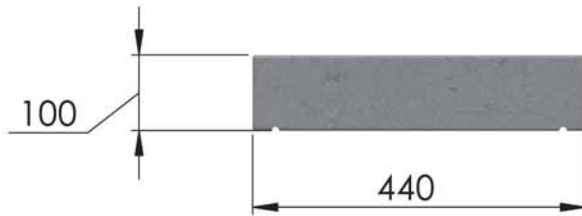

All dimensions are in millimetres. For non listed sizes please contact InGranite Recon LTD.

All vertical faces typically have a 4mm taper per 100mm of height.

The information contained in this drawing was correct at the time of going to print. Profiles, sizes and weights are given as indication only.



# InGranite Recon Ltd.

Reconstituted Stone | Modern Material | Classic Style

UK info@ingranite.co.uk

www.ingranite.co.uk

0808 2349118

RoI info@ingranite.ie

www.ingranite.ie

057 9331462

## Technical specification sheet

Title: 550 Flat wall cap

Date: 28/02/2017

Ref: FL 550

Scale: 1:10

Drawn by: InGranite

Approximate weight: 132kgs

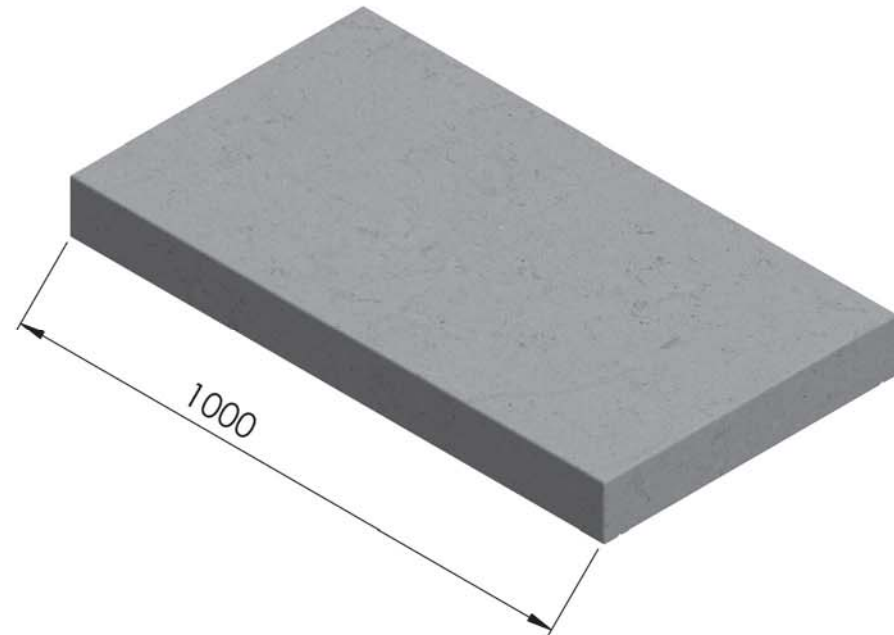
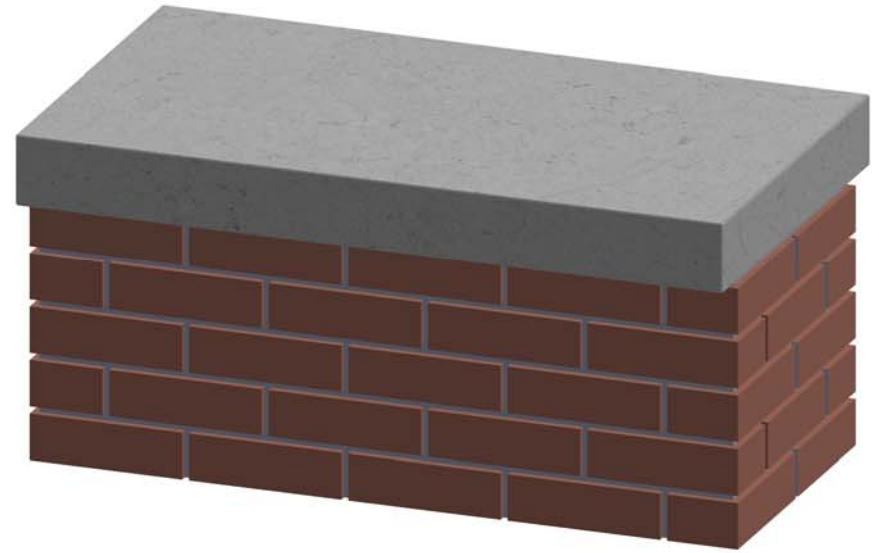
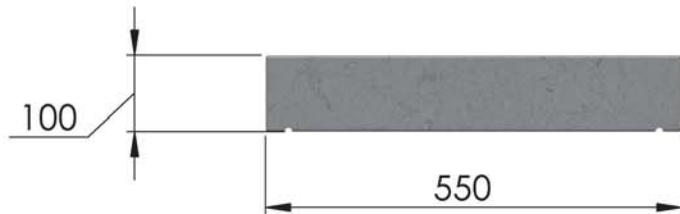

All dimensions are in millimetres. For non listed sizes please contact InGranite Recon LTD.

All vertical faces typically have a 4mm taper per 100mm of height.

The information contained in this drawing was correct at the time of going to print. Profiles, sizes and weights are given as indication only.



# InGranite Recon Ltd.

Reconstituted Stone | Modern Material | Classic Style

UK info@ingranite.co.uk

www.ingranite.co.uk

0808 2349118

RoI info@ingranite.ie

www.ingranite.ie

057 9331462

## Technical specification sheet

Title: Gem wall capping range

Date: 13/04/2017

Ref: GEM .....

Scale: 1:10

Drawn by: InGranite

Approximate weight: 127kgs to 182kgs

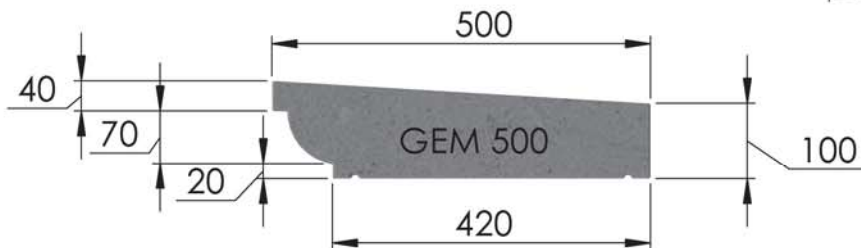
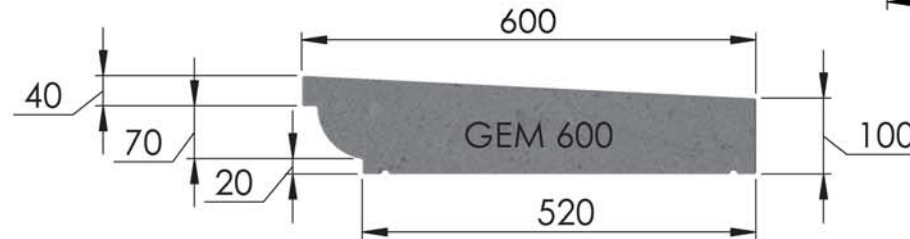
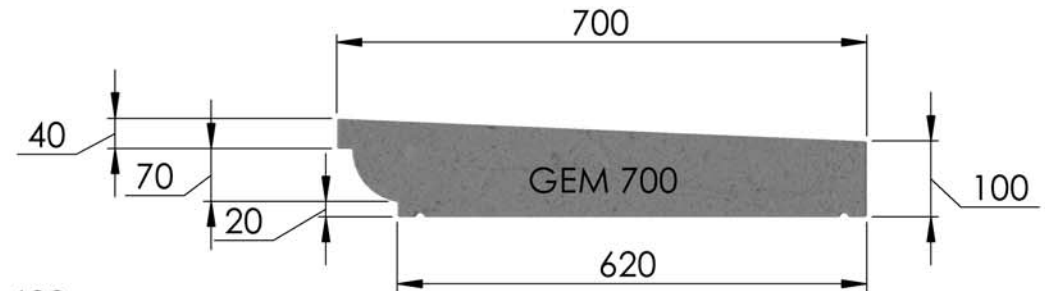
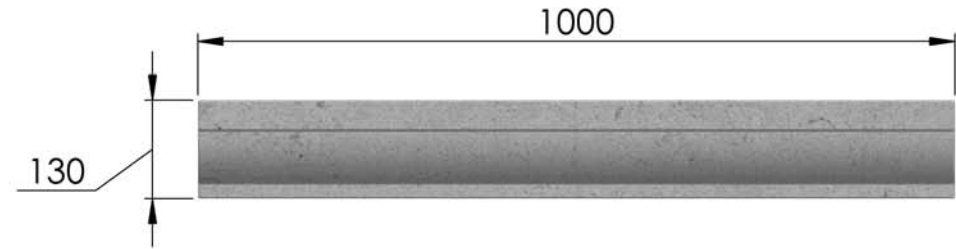

All dimensions are in millimetres. For non listed sizes please contact InGranite Recon LTD.

All vertical faces typically have a 4mm taper per 100mm of height.

The information contained in this drawing was correct at the time of going to print. Profiles, sizes and weights are given as indication only.



# InGranite Recon Ltd.

Reconstituted Stone | Modern Material | Classic Style

UK info@ingranite.co.uk

www.ingranite.co.uk

0808 2349118

RoI info@ingranite.ie

www.ingranite.ie

057 9331462

## Technical specification sheet

Title: Gem 500 wall capping

Date: 13/04/2017

Ref: GEM 500

Scale: 1:10

Drawn by: InGranite

Approximate weight:

127kgs/meter

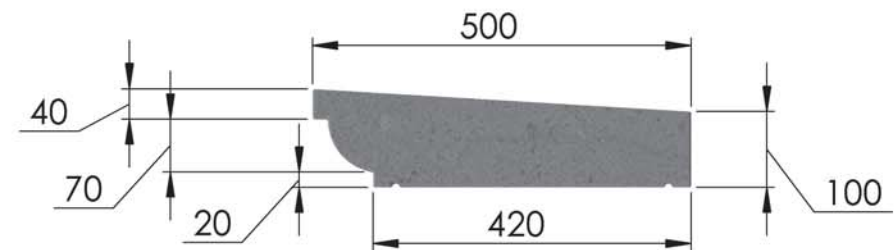
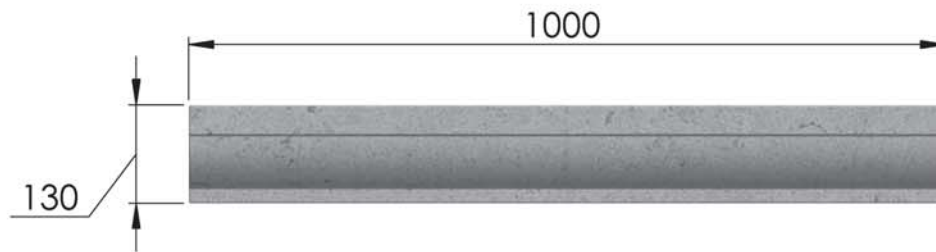

All dimensions are in millimetres. For non listed sizes please contact InGranite Recon LTD.

All vertical faces typically have a 4mm taper per 100mm of height.

The information contained in this drawing was correct at the time of going to print. Profiles, sizes and weights are given as indication only.



# InGranite Recon Ltd.

Reconstituted Stone | Modern Material | Classic Style

UK info@ingranite.co.uk

www.ingranite.co.uk

0808 2349118

RoI info@ingranite.ie

www.ingranite.ie

057 9331462

## Technical specification sheet

Title: GEM 600 wall capping

Date: 13/04/2017

Ref: GEM 600

Scale: 1:10

Drawn by: InGranite

Approximate weight: 154.5kgs/meter

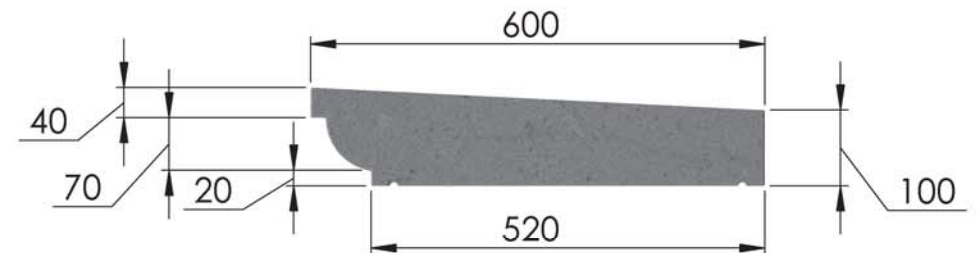
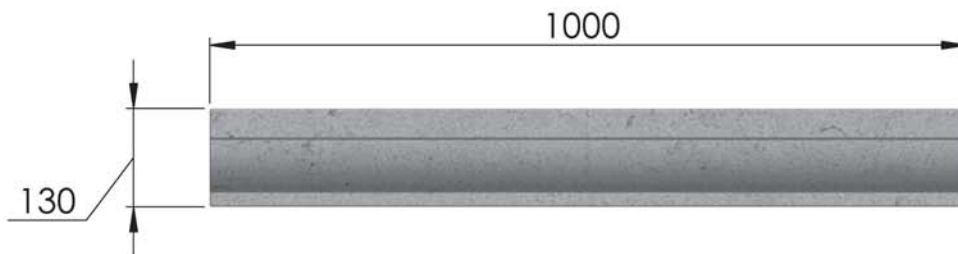

All dimensions are in millimetres. For non listed sizes please contact InGranite Recon LTD.

All vertical faces typically have a 4mm taper per 100mm of height.

The information contained in this drawing was correct at the time of going to print. Profiles, sizes and weights are given as indication only.



# InGranite Recon Ltd.

Reconstituted Stone | Modern Material | Classic Style

UK info@ingranite.co.uk

www.ingranite.co.uk

0808 2349118

RoI info@ingranite.ie

www.ingranite.ie

057 9331462

## Technical specification sheet

Title: Gem 700 wall capping

Date: 13/04/2017

Ref: GEM 700

Scale: 1:10

Drawn by: InGranite

Approximate weight:

182kgs/meter

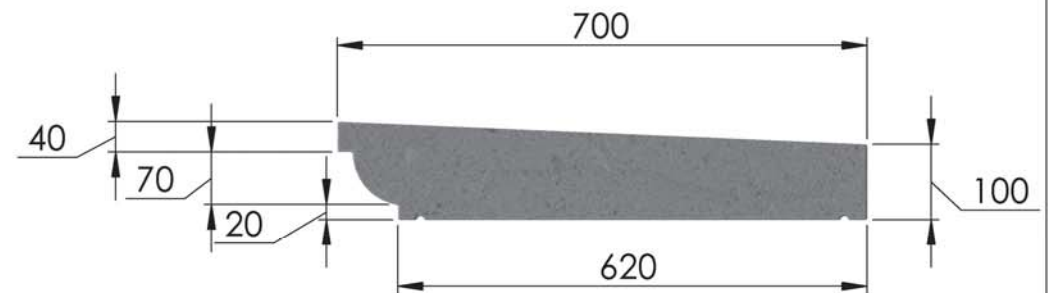
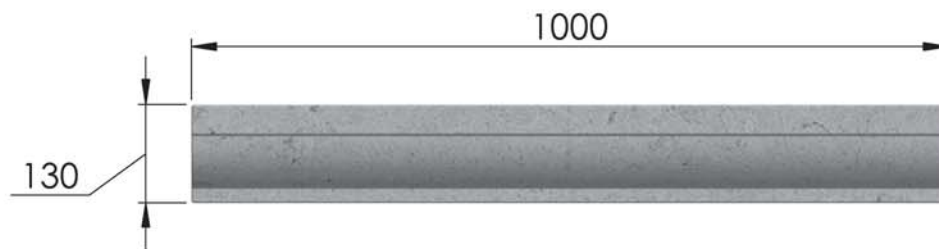

All dimensions are in millimetres. For non listed sizes please contact InGranite Recon LTD.

All vertical faces typically have a 4mm taper per 100mm of height.

The information contained in this drawing was correct at the time of going to print. Profiles, sizes and weights are given as indication only.



# InGranite Recon Ltd.

Reconstituted Stone | Modern Material | Classic Style

UK info@ingranite.co.uk

www.ingranite.co.uk

0808 2349118

RoI info@ingranite.ie

www.ingranite.ie

057 9331462

## Technical specification sheet

Title: Gem external corner cappings

Date: 13/04/2017

Ref: GEM/EX/...

Scale: 1:10

Drawn by: InGranite

Approximate weight:

Various

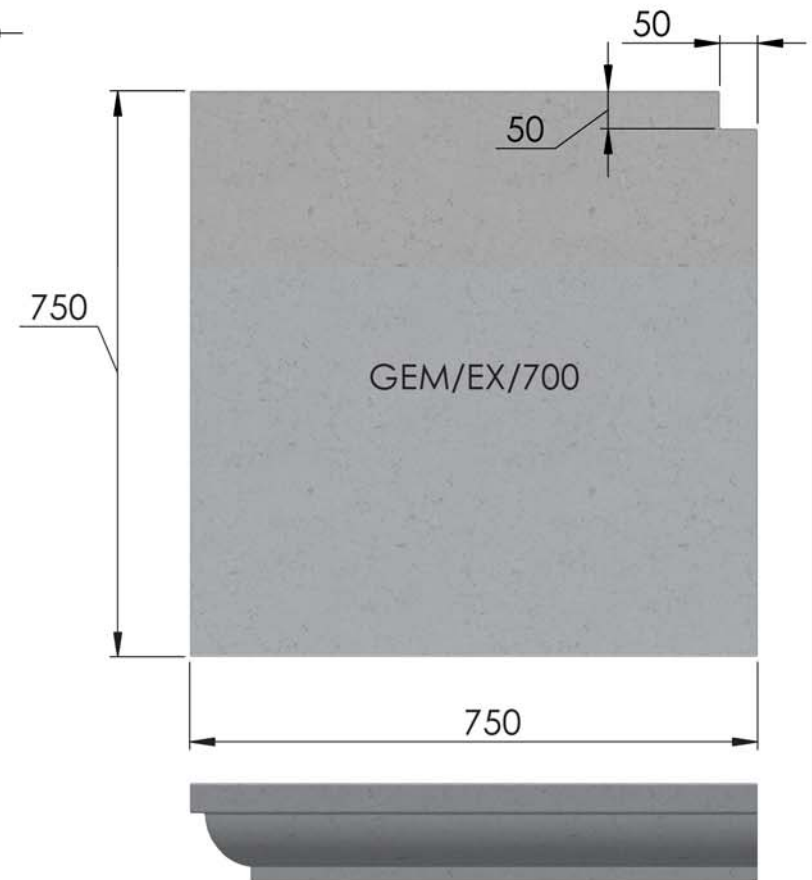
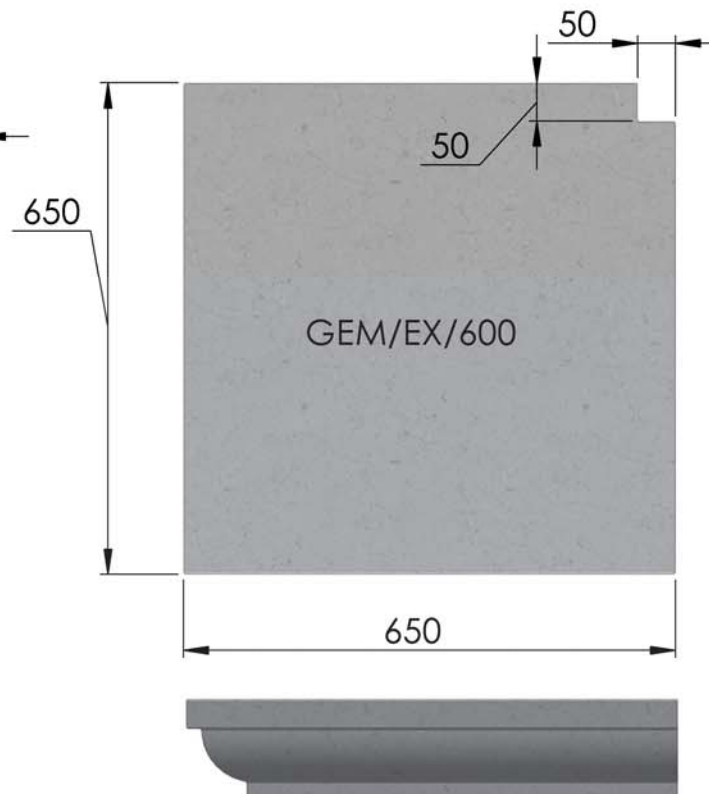
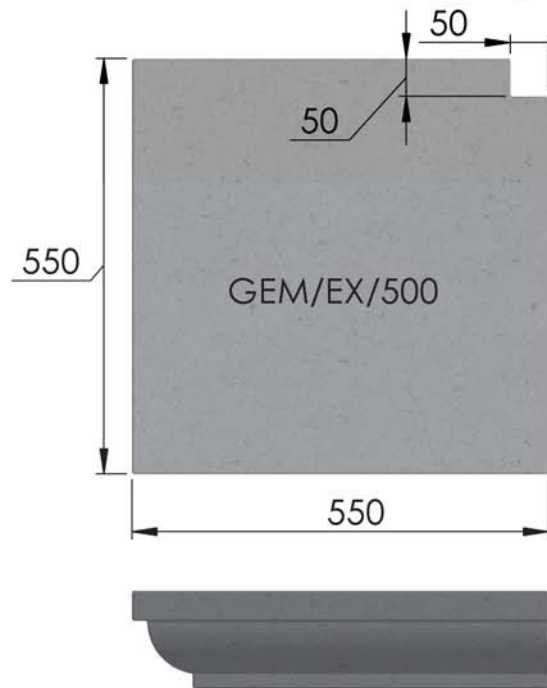

All dimensions are in millimetres. For non listed sizes please contact InGranite Recon LTD.

All vertical faces typically have a 4mm taper per 100mm of height.

The information contained in this drawing was correct at the time of going to print. Profiles, sizes and weights are given as indication only.







